

Canon

EOS 60D



Canon EOS 60D

INSTRUCTION MANUAL



E

INSTRUCTION
MANUAL

Introduction

The EOS 60D is a high-performance, digital single-lens reflex camera featuring a fine-detail CMOS sensor with approx. 18.0 effective megapixels, DIGIC 4, high-precision and high-speed 9-point AF, approx. 5.3 fps continuous shooting, Live View shooting, and Full HD (Full High-Definition) movie shooting.

The camera is highly responsive for shooting at anytime, provides many functions fitted for advanced shooting, and offers many other features.

Take Test Shots to Familiarize Yourself with the Camera

With a digital camera, you can immediately view the image you have captured. While reading this manual, take a few test shots and see how they come out. You can then better understand the camera.

To avoid botched pictures and accidents, first read the Safety Warnings (p.305, 306) and Handling Precautions (p.12, 13).

Testing the Camera Before Use and Liability

After shooting, playback and check whether the images have been properly recorded. If the camera or memory card is faulty and the images cannot be recorded or downloaded to a computer, Canon cannot be held liable for any loss or inconvenience caused.

Copyrights

Copyright laws in your country may prohibit the use of your recorded images of people and certain subjects for anything but private enjoyment. Also be aware that certain public performances, exhibitions, etc., may prohibit photography even for private enjoyment.



This camera is compatible with SD memory cards, SDHC memory cards, and SDXC memory cards. This manual will refer to all these cards as just "card."

*** The camera does not come with a card for recording images.**
Please purchase it separately.

Item Check List

Before starting, check that all the following items have been included with your camera. If anything is missing, contact your dealer.

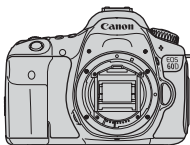

Camera
(with eyecup and
body cap)



**Battery Pack
LP-E6**
(with protective cover)



**Battery Charger
LC-E6/LC-E6E***



**Wide Strap
EW-EOS60D**



Interface Cable

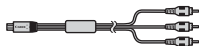

**Stereo AV Cable
AVC-DC400ST**



**EOS DIGITAL
Solution Disk**
(Software)



**Software
Instruction
Manual**



(1)

(1) Camera Instruction Manual
(this booklet)



(2)

(2) Pocket Guide

* Battery Charger LC-E6 or LC-E6E is provided. (The LC-E6E comes with a power cord.)

- If you purchased a Lens Kit, check that the lens is included.
- Depending on the Lens Kit type, the lens instruction manual might also be included.
- Be careful not to lose any of the above items.











Software Instruction Manual

The Software Instruction Manual is in the CD-ROM as a PDF file. See page 316 for instructions to look up things in the Software Instruction Manual.







Conventions Used in this Manual

Icons in this Manual

-  : Indicates the Main Dial.
-  : Indicates the Quick Control Dial.
-  <  > <  > : Indicates the Multi-controller and the push direction.
-  : Indicates the setting button.
-  ,  ,  ,  : Indicates that the respective function remains active for 4 sec., 6 sec., 10 sec., or 16 sec. respectively after you let go of the button.

* In this manual, the icons and markings indicating the camera's buttons, dials, and settings correspond to the icons and markings on the camera and on the LCD monitor.

- MENU** : Indicates a function which can be changed by pressing the <MENU> button and changing the setting.
- ☆ : If shown on the upper right of the page, it indicates that the function is available only in the Creative Zone modes (p.20).
- (p.**): Reference page numbers for more information.
-  : Tip or advice for better shooting.
-  : Problem-solving advice.
-  : Warning to prevent shooting problems.
-  : Supplemental information.

Basic Assumptions













- All operations explained in this manual assume that the power switch is already set to <ON> (p.28).
- It is assumed that all the menu settings and Custom Functions are set to the default.
- For explanatory purposes, the instructions show the camera attached with an EF-S18-135mm f/3.5-5.6 IS lens.

Chapters

For first-time DSLR users, Chapters 1 and 2 explain the camera's basic operations and shooting procedures.



	Introduction	2
1	Getting Started	23
2	Basic Shooting	53
3	Setting the AF and Drive Modes	75
4	Image Settings	83
5	Advanced Operations	111
6	Flash Photography	129
7	Shooting with the LCD Monitor (Live View Shooting)	151
8	Shooting Movies	171
9	Image Playback	189
10	Post-Processing Images	219
11	Sensor Cleaning	229
12	Printing Images	235
13	Customizing the Camera	249
14	Reference	265
	End Pages: Software Start Guide and Instruction Manual Index	313

Contents







Introduction	2
Item Check List.....	3
Conventions Used in this Manual.....	4
Chapters.....	5
Index to Features.....	10
Handling Precautions.....	12
Quick Start Guide.....	14
Nomenclature.....	16
1 Getting Started	23
Charging the Battery.....	24
Installing and Removing the Battery.....	26
Using the LCD Monitor.....	27
Turning on the Power.....	28
Setting the Date and Time.....	30
Selecting the Interface Language.....	31
Installing and Removing the SD Card.....	32
Attaching and Detaching a Lens.....	34
Using the Lens Hood.....	37
About the Lens Image Stabilizer.....	38
Basic Operation.....	39
 Using the Quick Control Screen.....	44
 Menu Operations.....	46
Before You Start.....	48
Formatting the Card.....	48
Setting the Power-off Time/Auto Power Off.....	50
Setting the Image Review Time.....	50
Reverting the Camera to the Default Settings.....	51
2 Basic Shooting	53
 Fully Automatic Shooting.....	54
 Full Auto Techniques.....	56
 Disabling Flash.....	58
 Creative Auto Shooting.....	59
 Shooting Portraits.....	62
 Shooting Landscapes.....	63
 Shooting Close-ups.....	64
 Shooting Moving Subjects.....	65
 Shooting Portraits at Night.....	66
 Quick Control Screen.....	67
Shoot by Ambience Selection.....	68

Shoot by Lighting or Scene Type	71
---------------------------------------	----





3 Setting the AF and Drive Modes 75

AF: Selecting the AF Mode.....	76
 Selecting the AF Point	78
When Autofocus Fails	80
MF: Manual Focusing	80
 Selecting the Drive Mode.....	81
 Using the Self-timer	82

4 Image Settings 83

Setting the Image-recording Quality.....	84
ISO: Setting the ISO Speed.....	88
 Selecting a Picture Style	90
 Customizing a Picture Style	92
 Registering a Picture Style.....	94
Setting the White Balance.....	96
 Custom White Balance	97
 Setting the Color Temperature.....	98
 White Balance Correction	99
Auto Lighting Optimizer.....	101
Lens Peripheral Illumination Correction	102
Creating and Selecting a Folder.....	104
File Numbering Methods	106
Setting Copyright Information.....	108
Setting the Color Space	110

5 Advanced Operations 111

P : Program AE.....	112
Tv : Shutter-Priority AE	114
Av : Aperture-Priority AE.....	116
Depth of Field Preview	117
M : Manual Exposure.....	118
 Selecting the Metering Mode	119
Setting Exposure Compensation.....	120
 Auto Exposure Bracketing (AEB)	121
 AE Lock	122
B : Bulb Exposures	123
Mirror Lockup	125
 Remote Control Shooting.....	126
 Displaying the Electronic Level	127



6	Flash Photography	129
	⚡ Using the Built-in Flash.....	130
	Setting the Flash	135
	Using Wireless Flash.....	139
	External Speedlites	148
7	Shooting with the LCD Monitor (Live View Shooting)	151
	📷 Shooting with the LCD Monitor	152
	Shooting Function Settings	156
	☰ Menu Function Settings.....	157
	Using AF to Focus	160
	Focusing Manually.....	167
8	Shooting Movies	171
	🎬 Shooting Movies.....	172
	Shooting Function Settings	179
	Setting the Movie-recording Size.....	180
	Menu Function Settings.....	182
9	Image Playback	189
	▶ Image Playback.....	190
	INFO. Shooting Information Display	191
	🔍📷 Searching for Images Quickly	194
	🔍/🔍 Magnified View.....	196
	🔄 Rotating the Image.....	197
	Setting Ratings	198
	📄 Quick Control During Playback.....	200
	🎬 Enjoying Movies	202
	🎬 Playing Movies	204
	✂ Editing the Movie's First and Last Scenes	206
	Slide Show (Auto Playback)	207
	Viewing the Images on TV.....	209
	🔒 Protecting Images.....	213
	🗑 Erasing Images.....	215
	Changing Image Playback Settings.....	217
	Adjusting the LCD Monitor Brightness	217
	Auto Rotation of Vertical Images	218
10	Post-Processing Images	219
	🎨 Creative Filters	220

 Resize	222
 Processing RAW Images with the Camera	224

11 Sensor Cleaning 229

 Automatic Sensor Cleaning	230
Appending Dust Delete Data	231
Manual Sensor Cleaning	233

12 Printing Images 235

Preparing to Print	236
 Printing	238
Trimming the Image	243
 Digital Print Order Format (DPOF)	245
 Direct Printing with DPOF	248

13 Customizing the Camera 249

Setting Custom Functions	250
Custom Functions	251
Custom Function Settings	252
C.Fn I : Exposure	252
C.Fn II : Image	254
C.Fn III : Autofocus/Drive	255
C.Fn IV : Operation/Others	257
Registering My Menu	261
C : Register Camera User Settings	262

14 Reference 265

INFO. Button Functions	266
Checking the Battery Information	268
Using a Household Power Outlet	272
Using Eye-Fi Cards	273
Function Availability Table According to Shooting Modes	276
Menu Settings	278
Troubleshooting Guide	283
Error Codes	291
System Map	292
Specifications	294
Safety Warnings	305

End Pages: Software Start Guide and Instruction Manual Index 313

Software Start Guide	314
Index	317

Index to Features

Power

- **Battery**
 - Charging → p.24
 - Battery check → p.29
 - Battery information check → p.268
- **Power outlet** → p.272
- **Auto power off** → p.50

Lens

- **Attaching/Detaching** → p.34
- **Zoom** → p.35
- **Image Stabilizer** → p.38

Basic Settings

- **Language** → p.31
- **Date/Time** → p.30
- **Using the LCD monitor** → p.27
- **LCD brightness adjustment** → p.217
- **Beeper** → p.278
- **Release shutter without card** → p.32

Recording Images

- **Format** → p.48
- **Create/select a folder** → p.104
- **File No.** → p.106

Image Quality

- **Image-recording quality** → p.84
- **ISO speed** → p.88
- **Picture Style** → p.90

- **White balance** → p.96
- **Color space** → p.110
- **Image enhancement features**
 - Auto Lighting Optimizer → p.101
 - Lens peripheral illumination correction → p.102
 - Noise reduction for long exposures → p.254
 - Noise reduction for high ISO speeds → p.254
 - Highlight tone priority → p.255

AF

- **AF mode** → p.76
- **AF point selection** → p.78
- **Manual focusing** → p.80

Drive

- **Drive modes** → p.81
- **Maximum burst** → p.87

Shooting

- **Electronic level** → p.127
- **Quick Control screen** → p.44
- **Creative Auto** → p.59
- **Program AE** → p.112
- **Shutter-priority AE** → p.114
- **Aperture-priority AE** → p.116
- **Manual exposure** → p.118
- **Bulb** → p.123
- **Mirror lockup** → p.125
- **Metering mode** → p.119

- Self-timer → p.82
- Remote control → p.126

Exposure Adjustments

- Exposure compensation → p.120
- AEB → p.121
- AE lock → p.122

Flash

- Built-in flash → p.130
 - Flash exposure compensation → p.132
 - FE lock → p.134
- External flash → p.148
- Flash control → p.135
 - Wireless flash → p.139

Live View Shooting

- Live View shooting → p.151
- Focusing → p.160
- Multiple aspect ratios → p.157
- Exposure simulation → p.158
- Grid display → p.157
- Silent shooting → p.159

Shooting Movies

- Movie shooting → p.171
- Manual exposure → p.174
- Sound recording → p.184

Image Playback

- Image review time → p.50
- Single image display → p.190
 - Shooting information display → p.191
- Movie playback → p.204
- Editing out movie first/last scene → p.206
- Index display → p.194
- Image browsing (Jump display) → p.195
- Magnified view → p.196
- Slide show → p.207
- Viewing images on TV → p.209
- Protect → p.213
- Erase → p.215

Image Editing

- Creative filters → p.220
- Resize → p.222
- RAW image processing → p.224

Customization

- Custom Functions (C.Fn) → p.250
- My Menu → p.261
- Camera user setting registration → p.262

Viewfinder

- Dioptic adjustment → p.39
- Electronic level → p.128
- Changing the focusing screen → p.259

Handling Precautions

Camera Care

- This camera is a precision instrument. Do not drop it or subject it to physical shock.
- The camera is not waterproof and cannot be used underwater. If you accidentally drop the camera into water, promptly consult your nearest Canon Service Center. Wipe off any water droplets with a dry cloth. If the camera has been exposed to salty air, wipe it with a well-wrung wet cloth.
- Never leave the camera near anything having a strong magnetic field such as a magnet or electric motor. Also avoid using or leaving the camera near anything emitting strong radio waves such as a large antenna. Strong magnetic fields can cause camera misoperation or destroy image data.
- Do not leave the camera in excessive heat such as in a car in direct sunlight. High temperatures can cause the camera to malfunction.
- The camera contains precision electronic circuitry. Never attempt to disassemble the camera yourself.
- Use a blower to blow away dust on the lens, viewfinder, reflex mirror, and focusing screen. Do not use cleaners that contain organic solvents to clean the camera body or lens. For stubborn dirt, take the camera to the nearest Canon Service Center.
- Do not touch the camera's electrical contacts with your fingers. This is to prevent the contacts from corroding. Corroded contacts can cause camera misoperation.
- If the camera is suddenly brought in from the cold into a warm room, condensation may form on the camera and internal parts. To prevent condensation, first put the camera in a sealed plastic bag and let it adjust to the warmer temperature before taking it out of the bag.
- If condensation forms on the camera, do not use the camera. This is to avoid damaging the camera. If there is condensation, remove the lens, card and battery from the camera, and wait until the condensation has evaporated before using the camera.
- If the camera will not be used for an extended period, remove the battery and store the camera in a cool, dry, well-ventilated location. Even while the camera is in storage, press the shutter button a few times once in a while to check that the camera is still working.
- Avoid storing the camera where there are corrosive chemicals such as a darkroom or chemical lab.
- If the camera has not been used for an extended period, test all its functions before using it. If you have not used the camera for some time or if there is an important shoot coming up, have the camera checked by your Canon dealer or check the camera yourself and make sure it is working properly.

LCD Panel and LCD Monitor

- Although the LCD monitor is manufactured with very high precision technology with over 99.99% effective pixels, there might be a few dead pixels among the remaining 0.01% or less pixels. Dead pixels displaying only black or red, etc., are not a malfunction. They do not affect the images recorded.
- If the LCD monitor is left on for a prolonged period, screen burn-in may occur where you see remnants of what was displayed. However, this is only temporary and will disappear when the camera is left unused for a few days.
- In low or high temperatures, the LCD monitor display may seem slow or it might look black. It will return to normal at room temperature.

Cards

To protect the card and its recorded data, note the following:

- Do not drop, bend, or wet the card. Do not subject it to excessive force, physical shock, or vibration.
- Do not store or use the card near anything having a strong magnetic field such as a TV set, speakers, or magnet. Also avoid places prone to having static electricity.
- Do not leave the card in direct sunlight or near a heat source.
- Store the card in a case.
- Do not store the card in hot, dusty, or humid locations.

Lens

After detaching the lens from the camera, attach the lens caps or put down the lens with the rear end up to avoid scratching the lens surface and electrical contacts.



Cautions During Prolonged Use

If you use continuous shooting, Live View shooting, or movie shooting for a prolonged period, the camera may become hot. Although this is not a malfunction, holding the hot camera for a long period can cause slight skin burns.

Quick Start Guide

1

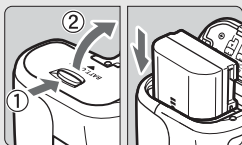

Insert the battery. (p.26)

To charge the battery, see page 24.

2

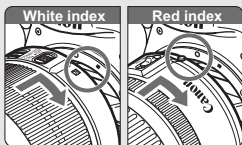

Attach the lens. (p.34)

Align the lens' white or red index with the camera's index in the matching color.

3

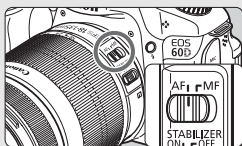

Set the lens focus mode switch to <AF>. (p.34)

4

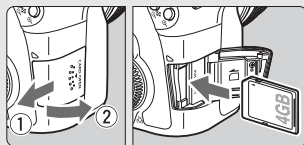

Open the slot cover and insert a card. (p.32)

With the card's label facing you, insert it into the slot.

5

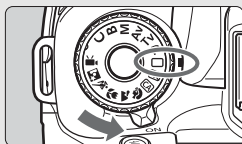

Set the power switch to <ON> (p.28), and while holding down the button at the center of the Mode Dial, turn the dial to **<Full Auto>** (p.54)

6

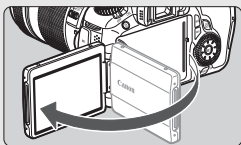

Flip out the LCD monitor. (p.27)

7



Focus the subject. (p.40)

Look through the viewfinder and aim the viewfinder center over the subject. Press the shutter button halfway, and the camera will focus the subject. If necessary, the built-in flash will pop-up automatically.

8

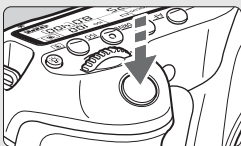

Take the picture. (p.40)

Press the shutter button completely to take the picture.

9



Review the picture. (p.50)

The captured image will be displayed for approx. 2 sec. on the LCD monitor. To display the image again, press the <▶> button (p.190).

- To shoot while looking at the LCD monitor, see page 57.
- To view the images captured so far, see “Image Playback” (p.190).
- To delete an image, see “Erasing Images” (p.215).

Nomenclature

For detailed information, reference page numbers are provided in parentheses (p.**).

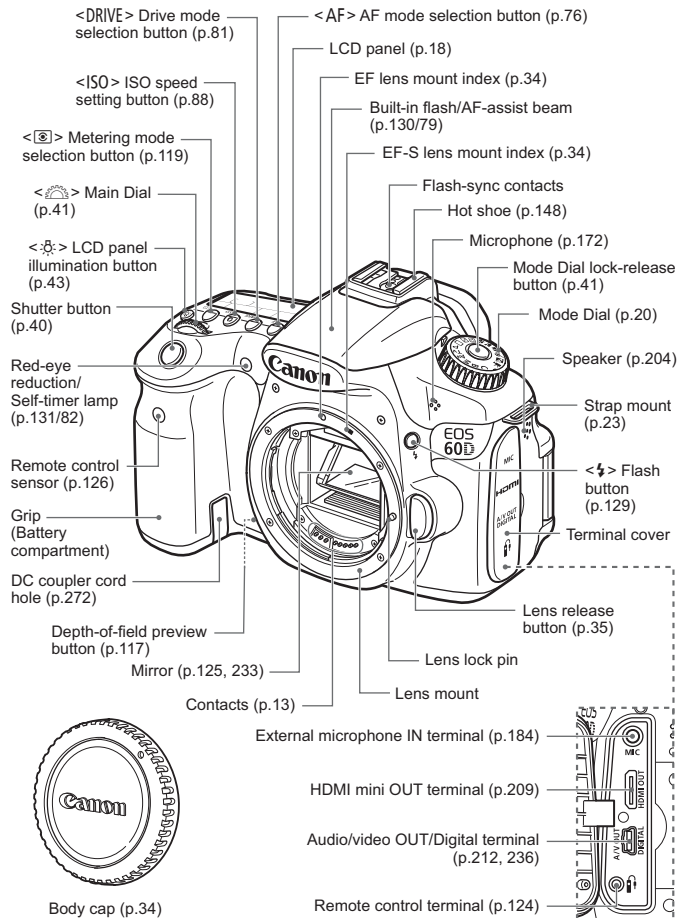

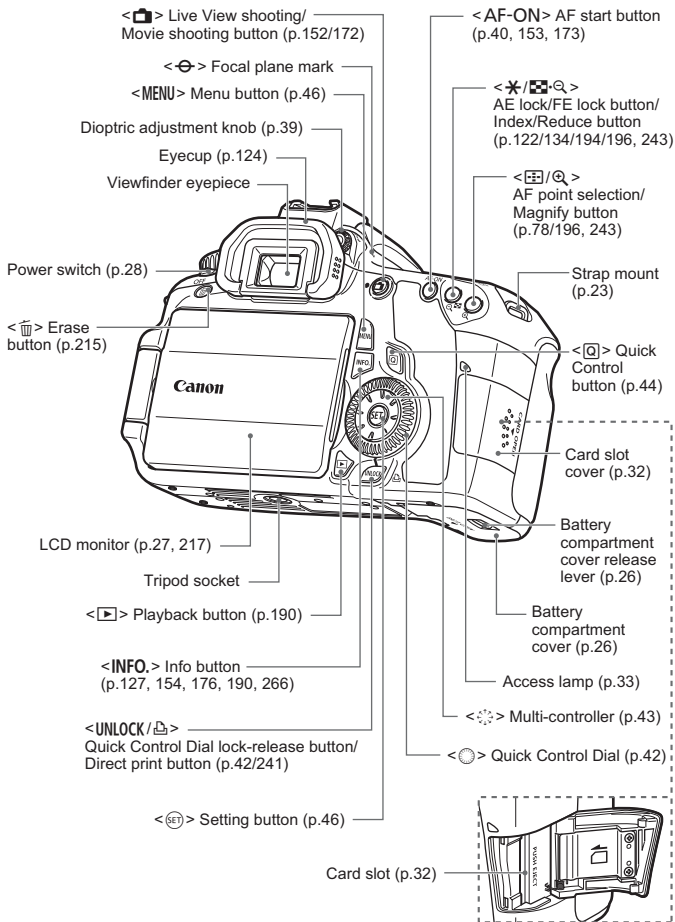

LCD Panel

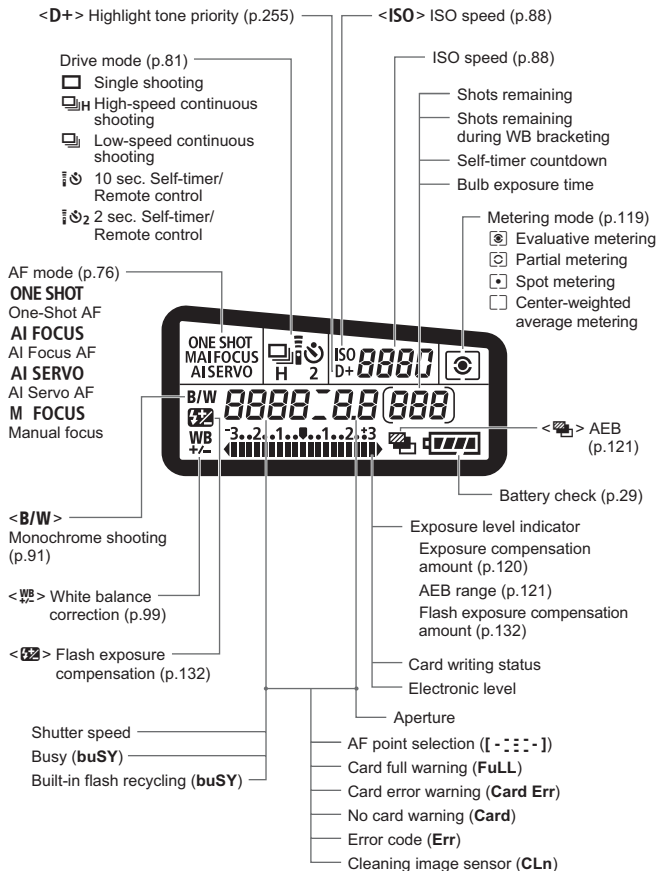

The display will show only the settings currently applied.

Viewfinder Information

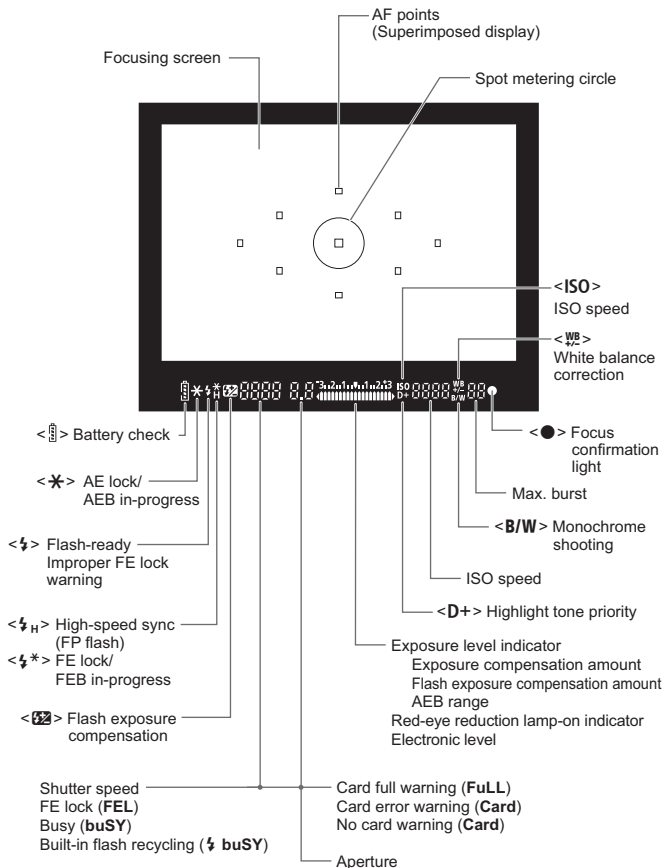

The display will show only the settings currently applied.

Mode Dial

Turn the Mode Dial while holding down the Mode Dial lock-release button at the center.

C: Camera User Setting

You can register the shooting mode (**P/Tv/Av/M/B**), AF mode, menu settings, etc., in this Mode Dial setting and shoot (p.262).

Creative Zone

These modes give you more control for shooting various subjects.

- P** : Program AE (p.112)
- Tv** : Shutter-priority AE (p.114)
- Av** : Aperture-priority AE (p.116)
- M** : Manual exposure (p.118)
- B** : Bulb (p.123)

Basic Zone

All you do is press the shutter button. Fully-automatic shooting suiting the subject.





-  : **Full Auto** (p.54)
-  : **Flash Off** (p.58)
-  : **Creative Auto** (p.59)

Image Zone

-  : Portrait (p.62)
-  : Landscape (p.63)
-  : Close-up (p.64)
-  : Sports (p.65)
-  : Night Portrait (p.66)

-  : **Movie shooting** (p.171)

Lens

Lens with a distance scale

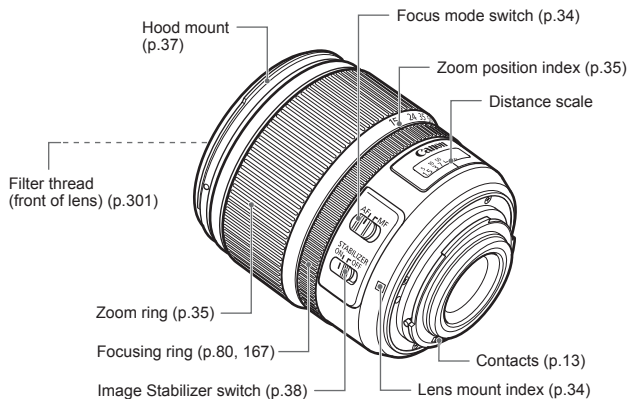

Lens without a distance scale

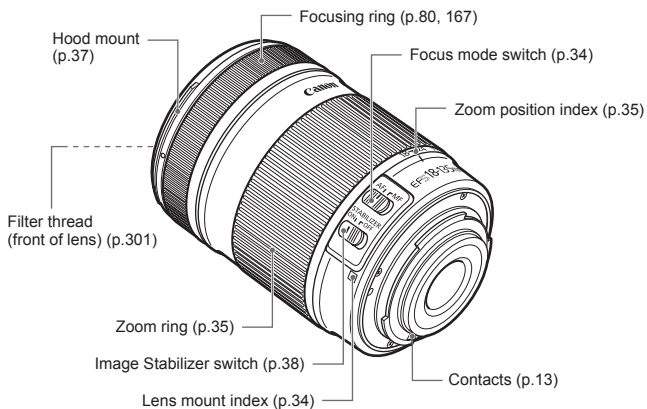

Battery Charger LC-E6

Charger for Battery Pack LP-E6 (p.24).

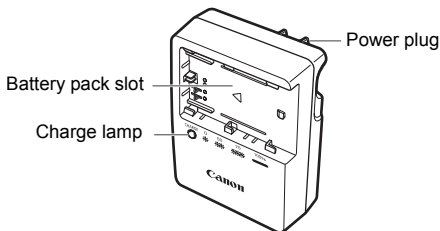

**IMPORTANT SAFETY INSTRUCTIONS-SAVE THESE INSTRUCTIONS.
DANGER-TO REDUCE THE RISK OF FIRE OR ELECTRIC SHOCK,
CAREFULLY FOLLOW THESE INSTRUCTIONS.**

For connection to a supply not in the U.S.A., use an attachment plug adapter of the proper configuration for the power outlet, if needed.

Battery Charger LC-E6E

Charger for Battery Pack LP-E6 (p.24).

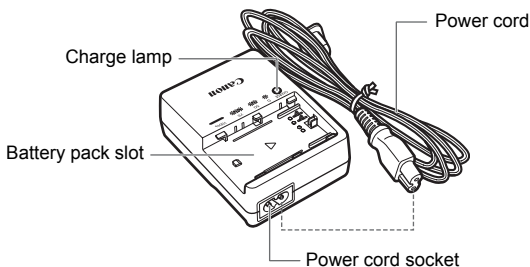

1

Getting Started

This chapter explains preparatory steps before you start shooting and basic camera operations.

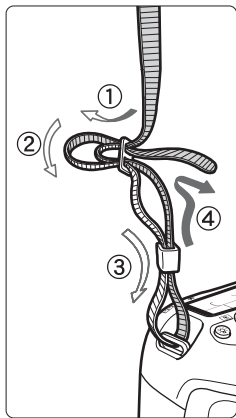

Attaching the Strap

Pass the end of the strap through the camera's strap mount eyelet from the bottom. Then pass it through the strap's buckle as shown in the illustration. Pull the strap to take up any slack and make sure the strap will not loosen from the buckle.

- The eyepiece cover is also attached to the strap (p.124).

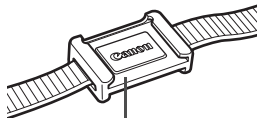

Eyepiece cover

Charging the Battery

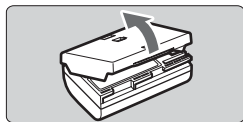

1 Remove the protective cover.

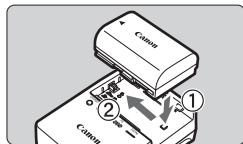

2 Attach the battery.

- As shown in the illustration, attach the battery securely to the charger.
- To detach the battery, follow the above procedure in reverse.

LC-E6

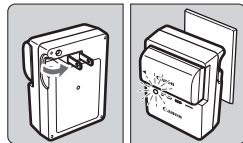

3 Recharge the battery.

For LC-E6

- As shown by the arrow, flip out the battery charger's prongs and insert the prongs into a power outlet.

LC-E6E

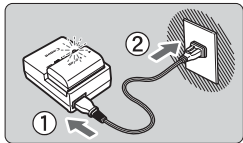

For LC-E6E

- Connect the power cord to the charger and insert the plug into the power outlet.
- ▶ Recharging starts automatically and the charge lamp blinks in orange.

Charge Level	Charge Lamp	
	Color	Indicator
0 - 49%	Orange	Blinks once per second
50 - 74%		Blinks twice per second
75% or higher		Blinks three times per second
Fully charged	Green	Lights on

- It takes approx. 2.5 hours to fully recharge a completely exhausted battery at 23°C / 73°F. The time required to recharge the battery depends on the ambient temperature and battery's charge level.
- For safety reasons, recharging in low temperatures (5°C - 10°C / 41°F - 50°F) will take a longer time (up to 4 hours).



Tips for Using the Battery and Charger

- **Recharge the battery on the day before or on the day it is to be used.**
Even during storage, a charged battery will gradually drain and lose its power.
- **After recharging the battery, detach it and detach the charger from the power outlet.**

- **You can attach the cover in a different orientation to indicate whether the battery has been recharged or not.**

If the battery has been recharged, attach the cover so that the battery-shaped hole <  > is

aligned over the blue sticker on the battery. If the battery is exhausted, attach the cover in the opposite orientation.

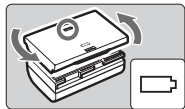

- **When not using the camera, remove the battery.**

If the battery is left in the camera for a prolonged period, a small amount of power current is released, resulting in excess discharge and shorter battery life. Store the battery with the protective cover attached. Storing the battery after it is fully charged can lower the battery's performance.

- **The battery charger can also be used in foreign countries.**

The battery charger is compatible with a 100 V AC to 240 V AC 50/60 Hz power source. If necessary, attach a commercially-available plug adapter for the respective country or region. Do not attach any portable voltage transformer to the battery charger. Doing so can damage the battery charger.

- **If the battery becomes exhausted quickly even after being fully charged, the battery has reached the end of its service life.**

Check the battery's recharge performance (p.268) and purchase a new battery.



- After disconnecting the charger's power plug, do not touch the prongs for at least 3 sec.
- If the battery's remaining capacity (p.268) is 94% or higher, the battery will not be recharged.
- The charger cannot charge any battery other than the Battery Pack LP-E6.

Installing and Removing the Battery

Installing the Battery

Load a fully-charged Battery Pack LP-E6 into the camera.

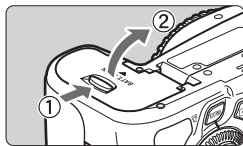

1 Open the battery compartment cover.

- Slide the lever as shown by the arrow and open the cover.

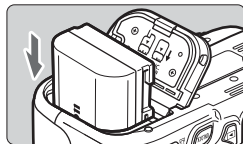

2 Insert the battery.

- Insert the end with the battery contacts.
- Insert the battery until it locks in place.

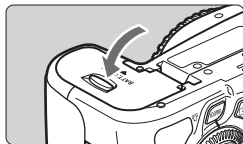

3 Close the cover.

- Press the cover until it snaps shut.

 Only the Battery Pack LP-E6 can be used.

Removing the Battery

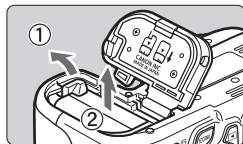

Open the cover and remove the battery.

- Press the battery release lever as shown by the arrow and remove the battery.
- To prevent short circuiting of the battery contacts, be sure to attach the protective cover to the battery.

Using the LCD Monitor

After you flip out the LCD monitor, you can set menu functions, use Live View shooting, shoot movies, and playback images and movies. You can change the direction and angle of the LCD monitor.

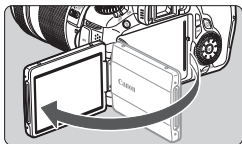

1 Flip out the LCD monitor.

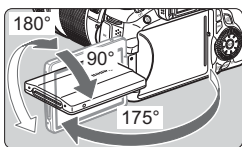

2 Rotate the LCD monitor.

- When the LCD monitor is swung out, you can rotate it up or down or face it forward toward the subject.
- The indicated angle is only approximate.

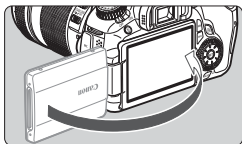

3 Face it toward you.

- Normally, face the LCD monitor toward you.



Be careful not to force and break the hinge when rotating the LCD monitor.



- When not using the camera, fold the LCD monitor back with the screen facing inward. This will protect the screen.
- During Live View shooting or movie shooting, facing the LCD monitor toward the subject will display a mirror image on the screen.
- Depending on the angle of the LCD monitor, the display may turn off right before the LCD monitor is folded back.

Turning on the Power

If you turn on the power switch and the date/time setting screen appears, see page 30 to set the date/time.

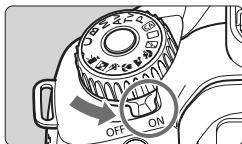

- <ON> : The camera turns on.
- <OFF> : The camera is turned off and does not operate. Set to this position when not using the camera.

About the Automatic Self-Cleaning Sensor

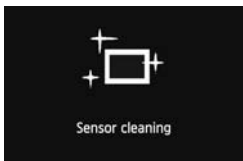

- Whenever you set the power switch to <ON> or <OFF>, the sensor cleaning will be executed automatically (A small sound may be heard). During the sensor cleaning, the LCD monitor will display <  >.

- Even during the sensor cleaning, you can still shoot by pressing the shutter button halfway (p.40) to stop the sensor cleaning and take a picture.
- If you repeatedly turn the power switch <ON>/<OFF> at a short interval, the <  > icon might not be displayed. This is normal and not a problem.

About Auto Power Off





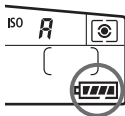

- To save battery power, the camera turns off automatically after approx. 1 minute of non-operation. To turn on the camera again, just press the shutter button halfway (p.40).
- You can change the auto power-off time with the menu's [ Auto power off] setting (p.50).

 If you set the power switch to <OFF> while an image is being recorded to the card, [**Recording ...**] will be displayed and the power will turn off after the card finishes recording the image.

Checking the Battery Level

When the power switch is set to <ON>, the battery level will be indicated in one of six levels: A blinking battery icon () indicates that the battery will be exhausted soon.





Icon						
Level (%)	100 - 70	69 - 50	49 - 20	19 - 10	9 - 1	0

Battery Life

Temperature	At 23°C / 73°F	At 0°C / 32°F
No Flash	Approx. 1600 shots	Approx. 1400 shots
50% Flash Use	Approx. 1100 shots	Approx. 1000 shots

- The figures above are based on a fully-charged Battery Pack LP-E6, no Live View shooting, and CIPA (Camera & Imaging Products Association) testing standards.
- Possible shots with Battery Grip BG-E9
 - With LP-E6 x 2: Approx. twice the shots without the battery grip.
 - With size-AA/LR6 alkaline batteries (at 23°C / 73°F): Approx. 550 shots without flash use, or approx. 410 shots with 50% flash use.



- The number of possible shots will decrease with any of the following operations:
 - Pressing the shutter button halfway for a prolonged period.
 - Often activating only the AF without taking a picture.
 - Using the LCD monitor often.
 - Using the lens Image Stabilizer.
- The lens operation is powered by the camera's battery. Depending on the lens used, the number of possible shots may be lower.
- For the number of possible shots with Live View shooting, see page 153.
- See the [ **Battery info.**] menu to further check the battery's condition (p.268).
- If size-AA/LR6 batteries are used in Battery Grip BG-E9, a four-level indicator will be displayed. (/) will not be displayed.)

MENU Setting the Date and Time

When you turn on the power for the first time or if the date/time has been reset, the Date/Time setting screen will appear. Follow steps 3 and 4 to set the date/time.

Note that the date/time appended to recorded images will be based on this date/time setting. Be sure to set the correct date/time.

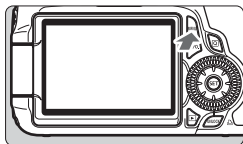

1 Display the menu.

- Press the <MENU> button to display the menu.

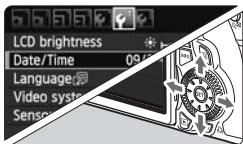

2 Under the [☛] tab, select [Date/Time].

- Press the <◀▶> key on the <☛> to select the [☛] tab.
- Press the <▲▼> key on the <☛> to select [Date/Time], then press <SET>.



3 Set the date and time.

- Press the <◀▶> key on the <☛> to select the date or time number.
- Press <SET> so <☛> is displayed.
- Press the <▲▼> key on the <☛> to set the number, then press <SET>.
(Returns to ☐.)

4 Exit the setting.

- Press the <◀▶> key on the <☛> to select [OK], then press <SET>.
- ▶ The date/time will be set and the menu will reappear.

! If you store the camera without the battery or if the camera's battery becomes exhausted, the date/time might be reset. If this happens, set the date/time again.

! The date/time set will start from when you press <SET> in step 4.

MENU Selecting the Interface Language

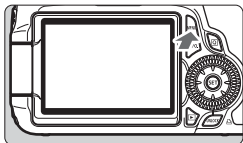

1 Display the menu.

- Press the <MENU> button to display the menu.

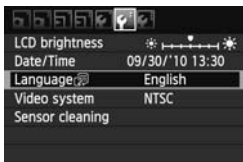

2 Under the [Language] tab, select [Language].

- Press the <◀▶> key on the <⊙> to select the [Language] tab.
- Press the <▲▼> key on the <⊙> to select [Language] (the third item from the top), then press <SET>.

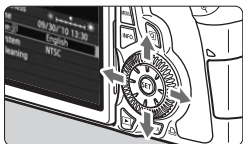

3 Set the desired language.

- Press the <▲▼> key on the <⊙> to select the language, then press <SET>.
- ▶ The interface language will change.

English	Norsk	Română
Deutsch	Svenska	Türkçe
Français	Español	العربية
Nederlands	Ελληνικά	ιταλίνα
Dansk	Русский	簡體中文
Português	Polski	繁體中文
Suomi	Čeština	한국어
Italiano	Magyar	日本語
Українська		

Installing and Removing the SD Card

The camera is compatible with SD, SDHC, and SDXC memory cards. The captured images are recorded onto the card (sold separately).

- **Make sure the card's write-protect switch is set upward to enable writing/erasing.**

Installing the Card

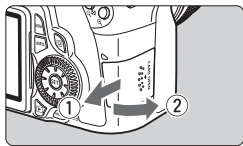

1 Open the cover.

- Slide the cover as shown by the arrows to open it.

Write-protect switch

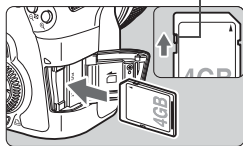

2 Insert the card.

- As shown by the illustration, face the top of the card toward you.
- Insert the card straight in all the way.

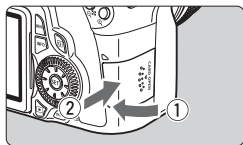

3 Close the cover.

- Close the cover and slide it in the direction shown by the arrows until it snaps shut.
- When you set the power switch to <ON>, the access lamp will blink and the number of possible shots will be displayed on the LCD panel.



Possible shots

- The number of possible shots depends on the remaining capacity of the card, image-recording quality, ISO speed, etc.
- Setting the [ Release shutter without card] menu option to [Disable] will prevent you from forgetting to install a card (p.278).

Removing the Card

Access lamp

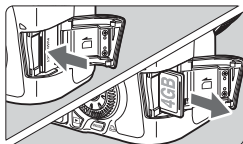
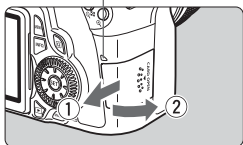

1 Open the cover.

- Set the power switch to <OFF>.
- Check that “Recording...” is not displayed on the LCD monitor.
- **Make sure the access lamp is off, then open the cover.**

2 Remove the card.

- Gently push in the card, then let go. The card will stick out.
- Pull the card straight out, then close the cover.



- **When the access lamp is lit or blinking, it indicates that the images are being written to or read by the card, being erased, or data is being transferred. While the access lamp is lit or blinking, never do any of the following. Doing so may damage the image data. It may also damage the card or camera.**
 - Opening the card slot cover.
 - Removing the battery.
 - Shaking or banging the camera around.
- If the card already contains recorded images, the image number might not start from 0001 (p.106).
- Do not touch the card's contacts with your fingers or metal objects.
- If a card-related error message is displayed on the LCD monitor, remove and reinstall the card. If the error persists, use a different card. If you can transfer all the images on the card to a computer, transfer all the images and then format the card with the camera (p.48). The card may then return to normal.
- SDHC and SDXC cards featuring UHS (Ultra High Speed) enable a maximum writing speed of SD Speed Class 10.

Attaching and Detaching a Lens

Attaching a Lens

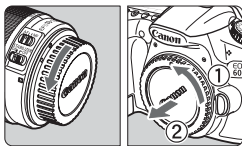

1 Remove the caps.

- Remove the rear lens cap and the body cap by turning them as shown by the arrows.

White index

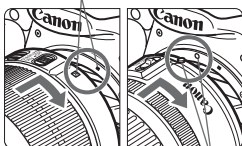

2 Attach the lens.

- Align the lens' red or white index with the camera's index matching the same color. Turn the lens as shown by the arrow until it snaps in place.

Red index

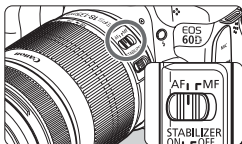

3 On the lens, set the focus mode switch to <AF> (autofocus).

- If it is set to <MF> (manual focus), autofocus will not operate.

4 Remove the front lens cap.

Minimizing Dust

- When changing lenses, do it in a place with minimal dust.
- When storing the camera without a lens attached, be sure to attach the body cap to the camera.
- Remove dust on the body cap before attaching it.

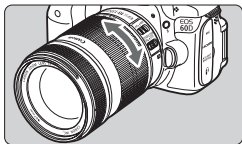
About Zooming

To zoom, turn the zoom ring on the lens with your fingers.

If you want to zoom, do it before focusing. Turning the zoom ring after achieving focus may throw off the focus slightly.

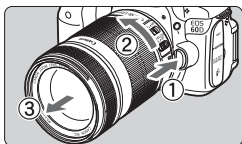
Detaching the Lens

While pressing the lens release button, turn the lens as shown by the arrow.

- Turn the lens until it stops, then detach it.
- Attach the rear lens cap to the detached lens.

To owners of the EF-S18-200mm f/3.5-5.6 IS lens:

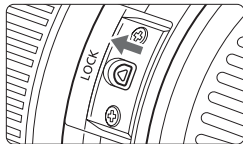

You can prevent the lens from extending out while you are carrying it around. Set the zoom ring to the 18mm wide-angle end, then slide the zoom ring lock lever to <LOCK>. The zoom ring can be locked only at the wide-angle end.

- Do not look at the sun directly through any lens. Doing so may cause loss of vision.
- If the front part (focusing ring) of the lens rotates during autofocus, do not touch the rotating part.



Image Conversion Factor

Since the image sensor size is smaller than the 35mm film format, it will look like the lens focal length is increased by 1.6x.

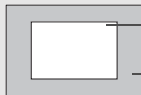

Image sensor size
(22.3 x 14.9 mm / 0.88 x 0.59 in.)
35mm image size
(36 x 24 mm / 1.42 x 0.94 in.)

Using the Lens Hood

When a lens hood is attached to the lens, it can reduce image ghosting or flare by blocking stray light. The lens hood can also protect the front of the lens from raindrops, snow, dust, etc.

Although the lens hood is usually sold separately, certain lens kit configurations have it included.

Attaching a Lens Hood without Index Marks

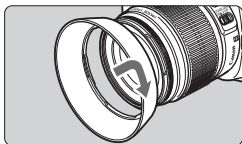

Attach the lens hood.

- Turn the lens hood as shown by the arrow until it attaches securely.

Attaching a Lens Hood with Index Marks

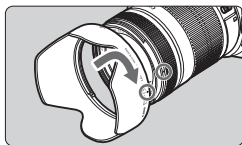

1 Align the red index marks on the lens hood and lens.

- Align the red index marks <●> on the lens hood and on the front of the lens.

2 Attach the lens hood.

- Turn the lens hood as shown by the arrow until the hood's <-○> mark aligns with the lens' <●> mark.



- To detach the lens hood, grasp the base of the hood when turning it. Grasping the hood's edges when turning it may deform the hood.
- If the lens hood is not properly attached, the hood might appear in the picture with the image periphery looking dark.
- Before using the built-in flash, detach the lens hood. Otherwise, the lens hood may partially block the flash and cause a darkened area in the picture.



The hood can be mounted in reverse on the lens for storage.

About the Lens Image Stabilizer

When you use the IS lens' built-in Image Stabilizer, camera shake is corrected to obtain a less blurred shot. The procedure explained here is based on the EF-S18-135mm f/3.5-5.6 IS lens as an example.

* IS stands for Image Stabilizer.

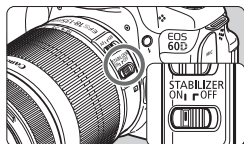

1 Set the IS switch to <ON>.

- Set also the camera's power switch to <ON>.

2 Press the shutter button halfway.

- ▶ The Image Stabilizer will operate.

3 Take the picture.

- When the picture looks steady in the viewfinder, press the shutter button completely to take the picture.

- ⚠ The Image Stabilizer may not be effective if the subject moves at the time of exposure.
- The Image Stabilizer may not be effective for excessive shaking such as on a rocking boat.

- 📄 The Image Stabilizer can operate with the lens focus mode switch set to either <AF> or <MF>.
- If the camera is mounted on a tripod, you can save battery power by switching the IS switch to <OFF>.
- The Image Stabilizer can operate even when the camera is mounted on a monopod.
- Some IS lenses enable you to switch the IS mode manually to suit the shooting conditions. However, the following lenses switch the IS mode automatically:
 - EF-S18-55mm f/3.5-5.6 IS II
 - EF-S15-85mm f/3.5-5.6 IS USM
 - EF-S18-135mm f/3.5-5.6 IS
 - EF-S18-200mm f/3.5-5.6 IS

Basic Operation

Adjusting the Viewfinder Clarity

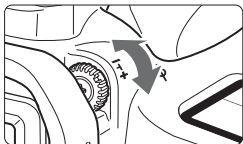

Turn the dioptic adjustment knob.

- Turn the knob left or right until the nine AF points in the viewfinder look sharp.



If the camera's dioptic adjustment still cannot provide a sharp viewfinder image, using Dioptic Adjustment Lens E (10 types, sold separately) is recommended.

Holding the Camera

To obtain sharp images, hold the camera still to minimize camera shake.

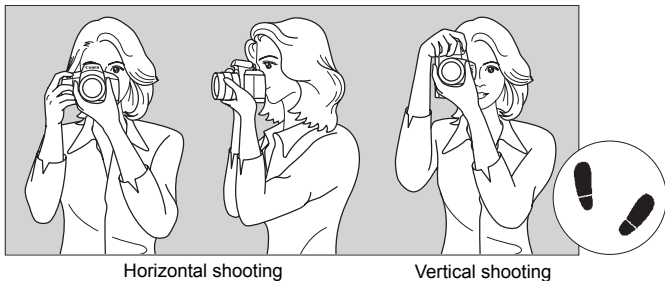

1. Wrap your right hand around the camera grip firmly.
2. Hold the lens bottom with your left hand.
3. Press the shutter button lightly with your right hand's index finger.
4. Press your arms and elbows lightly against the front of your body.
5. Press the camera against your face and look through the viewfinder.
6. To maintain a stable stance, place one foot in front of the other.



To shoot while looking at the LCD monitor, see page 57.

Shutter Button

The shutter button has two steps. You can press the shutter button halfway. Then you can further press the shutter button completely.

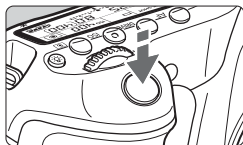

Pressing halfway

This activates autofocus and the automatic exposure system that sets shutter speed and aperture.

The exposure setting (shutter speed and aperture) is displayed on the LCD panel and in the viewfinder (ⓘ4).

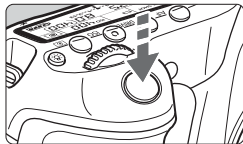

Pressing completely

This releases the shutter and takes the picture.

Preventing Camera Shake

Hand-held camera movement during the moment of exposure is called camera shake. It can cause blurred pictures. To prevent camera shake, note the following:

- Hold and steady the camera as shown on the previous page.
- Press the shutter button halfway to autofocus, then slowly press the shutter button completely.



- In Creative Zone modes, pressing the <AF-ON> button will be the same as pressing the shutter button halfway.
- If you press the shutter button completely without pressing it halfway first or if you press the shutter button halfway and then press it completely immediately, the camera will take a moment before it takes the picture.
- Even during the menu display, image playback, and image recording, you can instantly go back to shooting-ready by pressing the shutter button halfway.

Mode Dial

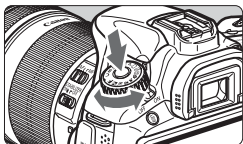

Turn the Mode Dial while holding down the Mode Dial lock-release button at the center.



Making Selections with the Main Dial

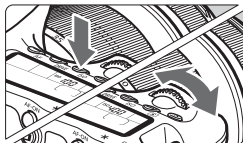

(1) After pressing a button, turn the < > dial.

When you press a button such as <AF>, <DRIVE>, or <ISO>, the respective function remains selected for 6 seconds (⌚6). During this time, you can turn the <  > dial to set the desired setting. When the function selection turns off or if you press the shutter button halfway, the camera will be ready to shoot.

- Use this dial to select or set the AF mode, drive mode, ISO speed, metering mode, AF point, etc.



(2) Turn the < > dial only.

While looking at the viewfinder or LCD panel, turn the <  > dial to set the desired setting.

- Use this dial to set the shutter speed, aperture, etc.

☉ Making Selections with the Quick Control Dial

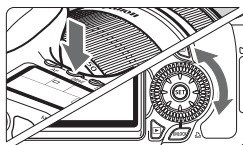

(1) After pressing a button, turn the <☉> dial.

When you press a button such as <AF>, <DRIVE>, or <ISO>, the respective function remains selected for 6 seconds (☉6). During this time, you can turn the <☉> dial to set the desired setting.

When the function selection turns off or if you press the shutter button halfway, the camera will be ready to shoot.

- Use this dial to select or set the AF mode, drive mode, ISO speed, metering mode, AF point, etc.

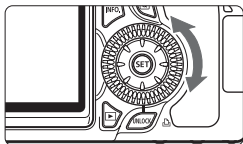

(2) Turn the <☉> dial only.

While looking at the viewfinder or LCD panel, turn the <☉> dial to set the desired setting.

- Use this dial to set the exposure compensation amount, the aperture setting for manual exposures, etc.

Using the UNLOCK button

In Creative Zone modes, you can set the [**☉ Lock**] menu setting to [**Enable**] to prevent the Quick Control Dial from inadvertently turning and changing the following settings:

- Exposure compensation (When shooting mode is **P/Tv/Av**.)
- Aperture setting with manual exposures
- Aperture setting with bulb exposures

With [**☉ Lock: Enable**] set, the <UNLOCK> button below the Quick Control Dial enables the [**☉ Lock**] setting to be canceled temporarily so that you can change the settings above. Press the <UNLOCK> button (☉4), then turn the <☉> dial. (☉16 in movie mode.)

Operating the Multi-controller

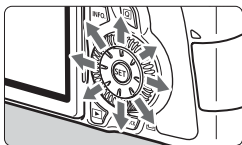

- Use it to select the AF point, correct the white balance, move the AF frame or the magnifying frame during Live View shooting, or scroll over the image during magnified view. You can push it in eight directions.
- For menus and the Quick Control screen, the Multi-controller works only in the <▲▼> and <◀▶> directions.

LCD Panel Illumination

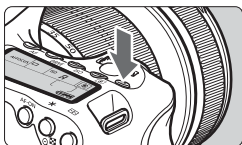

Turn on (☞6)/off the LCD panel illumination by pressing the <☞6> button. During a bulb exposure, pressing the shutter button completely will turn off the LCD panel illumination.

Displaying Shooting Settings

After you press the <INFO.> button a number of times, the shooting settings will be displayed. With the shooting settings displayed, you can turn the Mode Dial to see the settings for each shooting mode (p.266). To switch to the Quick Control screen, press the <Q> button (p.44, 67). To turn off the display, press the <INFO.> button.



Q Using the Quick Control Screen

You can directly select and set the shooting functions displayed on the LCD monitor. This is called the Quick Control screen.

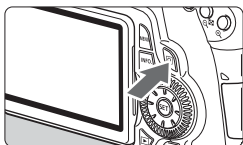

1 Display the Quick Control screen.

- Press the **<Q>** button.
- ▶ The Quick Control screen will appear (☺10).

2 Set the desired function.

- Press the **<▲▼>** **<◀▶>** key on the **<☼>** to select the function.
- ▶ The name of the selected function is displayed on the screen's bottom.
- Turn the **<☼>** or **<☺>** dial to change the setting.

Basic Zone modes

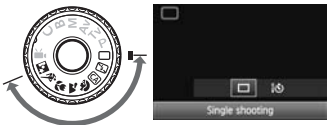

Creative Zone modes

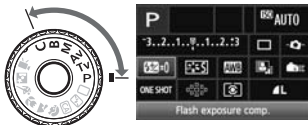

3 Take the picture.

- Press the shutter button completely to take the picture.
- ▶ The LCD monitor turns off and the captured image is displayed.

 In Basic Zone modes, the selectable functions may differ depending on the Basic Zone shooting mode (p.67).

Quick Control Screen Nomenclature

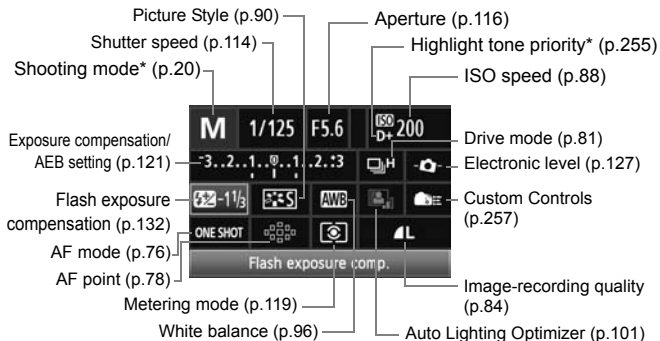

Asterisked functions cannot be set with the Quick Control screen.

Function Setting Display



- On the Quick Control screen, select the function and press <SET>. The function's setting screen will then appear (except for the shutter speed and aperture).
- Turn the <DISP> or <WB> dial to change the setting. With certain settings, you can also press the <◀▶> key to change it.
- Press <SET> to finalize the setting and return to the Quick Control screen. While on the <DISP>, <WB>, or <AF-ON> screen, you can return to the Quick Control screen by pressing the <MENU> button.

MENU Menu Operations

With menus, you can set various functions such as the image-recording quality, date/time, etc. While looking at the LCD monitor, press the <MENU> button on the camera back to display the menu screen and use the <▲▼> <◀▶> keys and <SET> button.

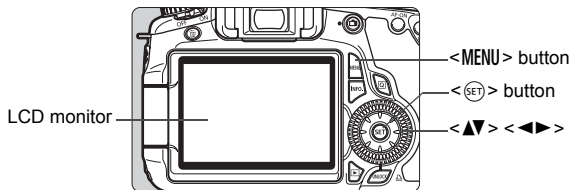

Menu Screen

In the Basic Zone, Creative Zone, and Movie shooting modes, the tabs and menu options displayed will be different.

Basic Zone modes



Movie shooting mode



Creative Zone modes

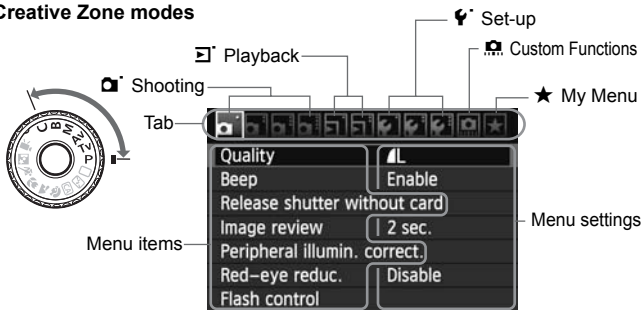

Menu Setting Procedure

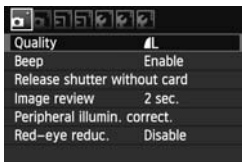

1 Display the menu screen.

- Press the <MENU> button to display the menu screen.

2 Select a tab.

- Press the <◀▶> key to select a menu tab.

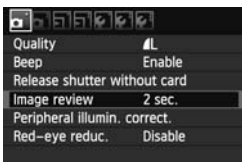

3 Select the desired item.

- Press the <▲▼> key to select the item, then press <SET>.

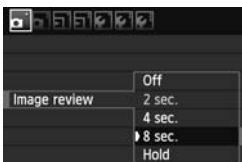

4 Select the setting.

- Press the <▲▼> or <◀▶> key to select the desired setting. (Some settings require you to press either the <▲▼> or <◀▶> key to select it.)
- The current setting is indicated in blue.

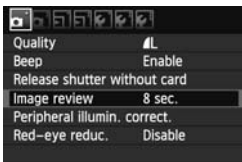

5 Set the desired setting.

- Press <SET> to set it.

6 Exit the setting.

- Press the <MENU> button to return to the shooting settings display.



- For Step 2, you can also turn the <◀▶> dial. For Step 4, you can also turn the <◉> dial depending on the setting.
- The explanation of menu functions hereinafter assumes that you have pressed the <MENU> button to display the menu screen.
- A list of menu functions is on page 278.

Before You Start

MENU Formatting the Card

If the card is new or was previously formatted by another camera or computer, format the card with the camera.

- !** When the card is formatted, all images and data in the card will be erased. Even protected images will be erased, so make sure there is nothing you need to keep. If necessary, transfer the images to a computer, etc., before formatting the card.

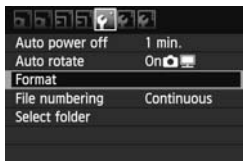

1 Select [Format].

- Under the [**F**] tab, select [**Format**], then press <[SET]>.



2 Format the card.

- Select [**OK**], then press <[SET]>.
- ▶ The card will be formatted.
- ▶ When the formatting is completed, the menu will reappear.



- For low-level formatting, press the <[✓]> button to checkmark [**Low level format**] with <[✓]>, then select [**OK**].



Execute [Format] in the following cases:

- The card is new.
- The card was formatted by a different camera or a computer.
- The card is full with images or data.
- A card-related error is displayed (p.291).

About Low-level Formatting

- Do low-level formatting if the card's recording or reading speed seems slow or if you want to totally erase all data in the card.
- Since low-level formatting will erase all recordable sectors in the card, the formatting will take slightly longer than normal formatting.
- You can stop the low-level formatting by selecting **[Cancel]**. Even in this case, normal formatting will have been completed and you can use the card as usual.



- When the card is formatted or data is erased, only the file management information is changed. The actual data is not completely erased. Be aware of this when selling or discarding the card. When discarding the card, execute low-level formatting or destroy the card physically to prevent the data from being leaked.
- Before using a new Eye-Fi card, the software in the card must be installed in your computer. Then format the card with the camera.



- The card capacity displayed on the card format screen might be smaller than the capacity indicated on the card.
- This device incorporates exFAT technology licensed from Microsoft.

MENU Setting the Power-off Time/Auto Power Off

You can change the auto power-off time for the camera to turn off automatically after a certain period of non-operation. If you do not want the camera to turn off automatically, set this to **[Off]**. After the power turns off, you can turn on the camera again by pressing the shutter button or other button.

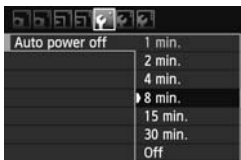
**1** Select **[Auto power off]**.

- Under the [**☑**] tab, select **[Auto power off]**, then press < **(SET)** >.

2 Set the desired time.

- Select the desired setting, then press < **(SET)** >.

 Even if **[Off]** has been set, the LCD monitor will turn off automatically after 30 min. to save power. (The camera's power does not turn off.)

MENU Setting the Image Review Time

You can set how long the image is displayed on the LCD monitor immediately after capture. To keep the image displayed, set **[Hold]**. To not have the image displayed, set **[Off]**.

1 Select **[Image review]**.

- Under the [**☑**] tab, select **[Image review]**, then press < **(SET)** >.

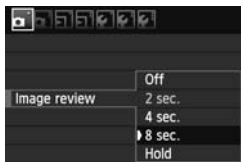
**2** Set the desired time.

- Select the desired setting, then press < **(SET)** >.

 If **[Hold]** is set, the image will be displayed until the auto power off time elapses.

MENU Reverting the Camera to the Default Settings ☆

The camera's shooting settings and menu settings can be reverted to the default.



1 Select [Clear all camera settings].

- Under the [F:] tab, select [Clear all camera settings], then press <SET>.



2 Select [OK].

- Select [OK], then press <SET>.
- ▶ Setting [Clear all camera settings] will reset the camera to the following default settings:







Shooting Settings

AF mode	One-Shot AF
AF point selection	Automatic selection
Metering mode	(Evaluative metering)
ISO speed	A (Auto)
ISO Auto	Max.: 3200
Drive mode	(Single shooting)
Exposure compensation/AEB	Canceled
Flash exposure compensation	0 (Zero)
Lock	Disable
Custom Functions	Unchanged

Image-recording Settings

Quality	
Picture Style	Standard
Auto Lighting Optimizer	Standard
Peripheral illumination correction	Enable/ Correction data retained
Color space	sRGB
White balance	(Auto)
Custom white balance	Canceled
WB correction	Canceled
WB-BKT	Canceled
File numbering	Continuous
Auto cleaning	Enable
Dust Delete Data	Erased





Camera Settings

Auto power off	1 min.
Beep	Enable
Release shutter without card	Enable
Image review	2 sec.
Highlight alert	Disable
AF point display	Disable
Histogram	Brightness
Image jump w/ 	 (10 images)
Auto rotate	On  
LCD brightness	  
Date/Time	Unchanged
Language	Unchanged
Video system	Unchanged
INFO. button display options	All items selected
Camera user settings	Unchanged
Copyright information	Unchanged
Control over HDMI	Disable
Eye-Fi transmission	Disable
My Menu settings	Unchanged

Live View Shooting Settings

Live View shooting	Enable
AF mode	Live mode
Grid display	Off
Aspect ratio	3:2
Exposure simulation	Enable
Silent shooting	Mode 1
Metering timer	16 sec.

Movie Shooting Settings

Movie exposure	Auto
AF mode	Live mode
AF w/ shutter button during 	Disable
AF and metering buttons for 	[0]
 ISO speed setting increments	1/3-stop increments
 Highlight tone priority	Disable
Movie recording size	1920x1080
Sound recording	Auto
Silent shooting	Mode 1
Metering timer	16 sec.
Grid display	Off

2

Basic Shooting

This chapter explains how to use the Basic Zone modes on the Mode Dial for best results.

With Basic Zone modes, all you do is point and shoot and the camera sets everything automatically (p.276). Also, to prevent botched pictures due to mistaken operations, major shooting settings cannot be changed in the fully-automatic modes.

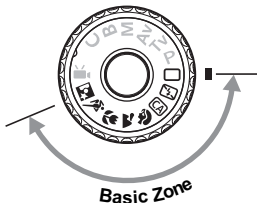

About the Auto Lighting Optimizer

In Basic Zone modes, the Auto Lighting Optimizer will adjust the image automatically to obtain the optimum brightness and contrast. It is also enabled by default in Creative Zone modes (p.101).

☐ Fully Automatic Shooting



AF point

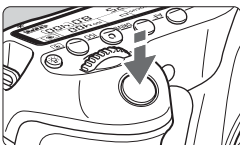
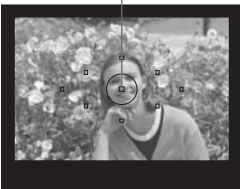

Focus confirmation light

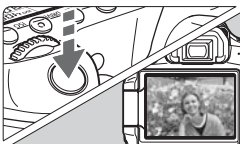

1 Set the Mode Dial to <☐>.

2 Aim any AF point over the subject.

- All the AF points will be used to focus, and generally the closest object will be focused.
- Aiming the center AF point over the subject will make focusing easier.

3 Focus the subject.

- Press the shutter button halfway, and the lens focusing ring will rotate to focus.
- ▶ The AF point achieving focus flashes briefly in red. At the same time, the beeper will sound and the focus confirmation light <●> in the viewfinder will light.
- ▶ If necessary, the built-in flash will pop-up automatically.

4 Take the picture.

- Press the shutter button completely to take the picture.
- ▶ The captured image will be displayed for approx. 2 sec. on the LCD monitor.
- If the built-in flash has popped up, you can push it back down with your fingers.

? FAQ

- **The focus confirmation light <●> blinks and focus is not achieved.**
Aim the AF point over an area having good contrast, then press the shutter button halfway (p.80). If you are too close to the subject, move away and try again.
- **Sometimes multiple AF points flash simultaneously.**
This indicates that focus has been achieved at all those AF points. As long as the AF point covering the desired subject flashes, you can take the picture.
- **The beeper continues to beep softly. (The focus confirmation light <●> does not light.)**
It indicates that the camera is focusing continuously on a moving subject. (The focus confirmation light <●> does not light.) You can shoot a moving subject in focus.
- **Pressing the shutter button halfway does not focus the subject.**
If the focus mode switch on the lens is set to <MF> (Manual Focus), set it to <AF> (Auto Focus).
- **Although it is daylight, the flash popped up.**
For a backlit subject, the flash may pop up to help lighten the subject's dark areas.
- **In low light, the built-in flash fired a series of flashes.**
Pressing the shutter button halfway may trigger the built-in flash to fire a series of flashes to assist autofocusing. This is called the AF-assist beam. It is effective up to approx. 4 meters/13.1 feet away.
- **Although flash was used, the picture came out dark.**
The subject was too far away. The subject should be within 5 meters/16.4 feet from the camera.
- **When flash was used, the bottom part of the picture came out unnaturally dark.**
The subject was too close to the camera, and a shadow was created by the lens barrel. The subject should be at least 1 meter/3.3 feet away from the camera. If a hood has been attached to the lens, remove it before taking the flash picture.

Full Auto Techniques

Recomposing the Shot



Depending on the scene, position the subject toward the left or right to create a balanced background and good perspective.

In the (Full Auto) mode, while you press the shutter button halfway to focus a still subject, the focus will be locked. You can then recompose the shot and press the shutter button completely to take the picture. This is called “focus lock”. Focus lock is also possible in other Basic Zone modes (except Sports).

Shooting a Moving Subject



In the (Full Auto) mode, if the subject moves (distance to camera changes) during or after you focus, AI Servo AF will take effect to focus the subject continuously. As long as you keep aiming the AF point on the subject while pressing the shutter button halfway, the focusing will be continuous. When you want to take the picture, press the shutter button completely.

Live View Shooting

By pressing the  button, you can shoot while viewing the image on the camera's LCD monitor. This is called Live View shooting. For details, see page 151.



1 Display the shooting image on the LCD monitor.

- Press the  button.
- ▶ The image will appear on the LCD monitor.



2 Focus the subject.

- Aim the center AF point  on the subject.
- Press the shutter button halfway to focus.

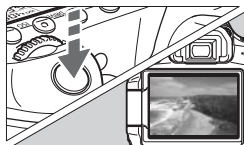

3 Take the picture.

- Press the shutter button completely.
- ▶ The picture will be taken and the captured image is displayed on the LCD monitor.
- ▶ After the image review ends, the camera will return to Live View shooting automatically.
- Press the  button to exit Live View shooting.

You can also rotate the LCD monitor in different directions (p.27).



Normal angle



Low angle



High angle

Disabling Flash

In places where flash photography is prohibited, use the <> (Flash Off) mode. This mode is also effective for capturing the particular ambience of a scene, such as candlelight scenes.

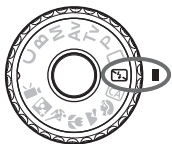

Shooting Tips

- **If the numeric display in the viewfinder blinks, take care to prevent camera shake.**

Under low light when camera shake is prone to occur, the viewfinder's shutter speed display will blink. Hold the camera steady or use a tripod. When using a zoom lens, use the wide-angle end to reduce blur caused by camera shake.

- **Taking portraits without flash.**

Under low light, the person must not move until the picture is taken. If the person moves during the exposure, he or she might look blurred in the picture.

CA Creative Auto Shooting

Unlike the **<□>** Full Auto mode where the camera sets everything, the **<CA>** Creative Auto mode enables you to easily set the depth of field, drive mode, and flash firing.

You can also choose the ambience you want to convey in your images. The default setting is the same as the **<□>** (Full Auto) mode.

* CA stands for Creative Auto.



1 Set the Mode Dial to **<CA>**.



2 Press the **<Q>** button.

- ▶ The Quick Control screen will appear on the LCD monitor.



3 Select a function.

- Press the **<▲▼>** key to select a function.
- ▶ A brief description of the selected function is displayed on the screen's bottom.
- For details on setting each function, see pages 60-61.

4 Take the picture.

- Press the shutter button completely to take the picture.



If you change the shooting mode or if you turn off the power, the Creative Auto settings will revert to the default. However, the self-timer and remote control settings will be retained.

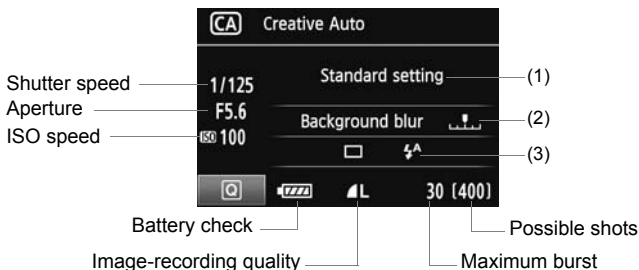

(1) Shoot by ambience selection

You can set the ambience you want to convey in your images. Press the <◀▶> key to select the desired ambience. You can also turn the <⊙> or <⊕> dial to select the ambience. For details, see page 68.

(2) Blurring/sharpening the background



If you move the index mark toward the left, the background will look more blurred. If you move it toward the right, the background will look more in focus. If you want to blur the background, see “Shooting Portraits” on page 62. Press the <◀▶> key to set the desired effect. You can also turn the <⊙> or <⊕> dial.

Depending on the lens and shooting conditions, the background might not look so blurred. This setting cannot be set (grayed out) while the built-in flash is popped up. If flash is used, this setting will not be applied.

(3) Drive mode/Flash firing

When you press <SET>, the drive mode and flash firing setting screens will appear. Set as desired and press <SET> to finalize the setting and return to the Quick Control screen.

Drive mode: Turn the <DIAL> dial to set it as desired.

<[]> (Low-speed continuous shooting): Shoot continuously at a maximum of approx. 3 frames per second (fps).

<[]> (Self-timer: 10-sec./Remote control): When you press the shutter button, the picture will be taken after a 10-sec. delay. See the [] notes for “Using the Self-timer” on page 82.

Remote control shooting is also possible (p.126).

* You can also set the drive mode on the LCD panel while the Quick Control screen is not displayed. Look at the LCD panel, press the <DRIVE> button, and turn the <DIAL> or <DIAL> dial to set as desired.

Flash firing: Press the <[]> key to set it as desired.

<[]> (Auto flash), <[]> (Flash on), or <[]> (Flash off) can be selected.

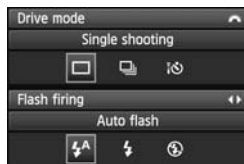

Shooting Portraits

The (Portrait) mode blurs the background to make the human subject stand out. It also makes skin tones and the hair look softer than with the (Full Auto) mode.



Shooting Tips

- **The farther the distance between the subject and background, the better.**

The further the distance between the subject and background, the more blurred the background will look. The subject will also stand out better in front of a plain, dark background.

- **Use a telephoto lens.**

If you have a zoom lens, use the telephoto end to fill the frame with the subject from the waist up. Move in closer if necessary.



- **Focus the face.**

Check that the AF point covering the face flashes in red.



- If you hold down the shutter button, you can shoot continuously to obtain different poses and facial expressions. (max. approx. 3 shots/sec.)
- If necessary, the built-in flash will pop up automatically.

Shooting Landscapes

Use the <> (Landscape) mode for wide scenery, night scenes, or to have everything in focus from near to far. The greens and blues also become more vivid and sharper than with <> (Full Auto).





Shooting Tips

- **With a zoom lens, use the wide-angle end.**

When using the wide-angle end of a zoom lens, objects near and far will be in focus better than at the telephoto end. It also adds breadth to landscapes.

- **Shooting night scenes.**

Since the built-in flash will be disabled, this mode <> is also good for night scenes. Use a tripod to prevent camera shake. If you want to photograph a person against a night scene, set the Mode Dial to <> (Night Portrait) and use a tripod (p.66).



Shooting Close-ups

When you want to photograph flowers or small things up close, use the  (Close-up) mode. To make small things appear much larger, use a macro lens (sold separately).





Shooting Tips

- **Use a simple background.**

A simple background makes the flower, etc., stand out better.

- **Move to the subject as close as possible.**

Check the lens for its minimum focusing distance. Some lenses have indications such as  **0.45m/1.5ft**. The lens minimum focusing distance is measured from the  (focal plane) mark on the camera to the subject. If you are too close to the subject, the focus confirmation light  will blink.

Under low light, the built-in flash will fire. If you are too close to the subject and the bottom of the picture looks dark, move away from the subject.

- **With a zoom lens, use the telephoto end.**

If you have a zoom lens, using the telephoto end will make the subject look larger.

Shooting Moving Subjects

To photograph a moving subject, whether it is a child running or a moving vehicle, use the  (Sports) mode.

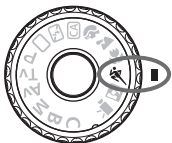

Shooting Tips

- **Use a telephoto lens.**

Using a telephoto lens is recommended so you can shoot from afar.

- **Use the center AF point to focus.**

Aim the center AF point over the subject, then press the shutter button halfway to auto focus. During autofocusing, the beeper will continue beeping softly. If focus cannot be achieved, the focus confirmation light  will blink.

When you want to take the picture, press the shutter button completely. If you hold down the shutter button, continuous shooting (max. approx. 5.3 shots per sec.) and autofocusing will take effect.





Under low light when camera shake is prone to occur, the viewfinder's shutter speed display on the bottom left will blink. Hold the camera steady and shoot.

Shooting Portraits at Night

To shoot someone at night and obtain a natural-looking exposure in the background, use the  (Night Portrait) mode.



Shooting Tips

- **Use a wide-angle lens and a tripod.**
When using a zoom lens, use the wide-angle end to obtain a wide night view. Also, use a tripod to prevent camera shake.
- **Keep the person within 5 meters/16.4 feet from the camera.**
Under low light, the built-in flash will fire automatically to obtain a good exposure of the person. The effective distance of the built-in flash is 5 meters/16.4 feet from the camera.
- **Shoot also with  (Full Auto).**
Since camera shake is prone to occur with night shots, shooting also with  (Full Auto) is recommended.



- Tell the subject to keep still even after the flash fires.
- If the self-timer is also used, the self-timer lamp will light briefly when the picture is taken.

Q Quick Control Screen

In Basic Zone modes, you can press the <Q> button to display the Quick Control screen. The table below indicates the functions that can be set with the Quick Control screen in each Basic Zone mode. For the setting procedure, see page 44.

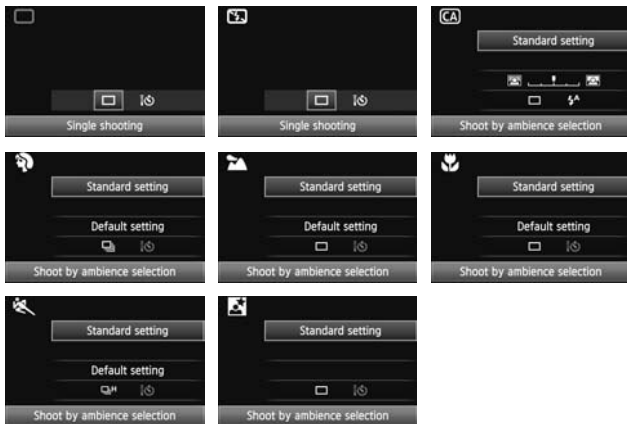

Settable Functions on the Quick Control Screen in Basic Zone Modes

● : Automatically set ○ : User selectable □ : Not selectable

Function									
		(p.54)	(p.58)	(p.59)	(p.62)	(p.63)	(p.64)	(p.65)	(p.66)
Drive	Single shooting	○	○	○		○	○		○
	Continuous shooting	Low-speed			○	○			
		High-speed							○
	Self-timer: 10 sec./Remote control		○	○	○	○	○	○	○
Flash firing	Automatic firing	●		○	●		●		●
	Flash on			○					
	Flash off		●	○		●		●	
Shoot by ambience selection (p.68)				○	○	○	○	○	○
Shoot by lighting or scene type (p.71)					○	○	○	○	
Blurring/sharpening the background (p.60)				○					

Shoot by Ambience Selection

Except in the <□> (Full Auto) and <📷> (Flash Off) Basic Zone modes, you can select the ambience for shooting.

Ambience	□	📷	CA	👤	🏔️	🌸	🌿	🏠	Ambience Effect
(1) Standard setting			○	○	○	○	○	○	No setting
(2) Vivid			○	○	○	○	○	○	Low / Standard / Strong
(3) Soft			○	○	○	○	○	○	Low / Standard / Strong
(4) Warm			○	○	○	○	○	○	Low / Standard / Strong
(5) Intense			○	○	○	○	○	○	Low / Standard / Strong
(6) Cool			○	○	○	○	○	○	Low / Standard / Strong
(7) Brighter			○	○	○	○	○	○	Low / Medium / High
(8) Darker			○	○	○	○	○	○	Low / Medium / High
(9) Monochrome			○	○	○	○	○	○	Blue / B/W / Sepia

- 1 Set the Mode Dial to any of the following modes: <CA> <👤> <🏔️> <🌸> <🌿> <🏠>



- 2 Display the Live View image.
 - Press the <📷> button to switch to Live View shooting.



- 3 On the Quick Control screen, select the desired ambience.

- Press the <Q> button (🕒10).
- Press the <▲▼> key to select [Standard setting]. [Shoot by ambience selection] will appear on the screen's bottom.
- Press the <◀▶> key to select the desired ambience.
- ▶ The LCD monitor will show how the image will look with the selected ambience.



4 Set the ambience effect.

- Press the <▲▼> key to select the effect bar so that **[Effect]** appears on the bottom.
- Press the <◀▶> key to select the desired effect.

5 Take the picture.

- To shoot while the Live View image is displayed, press the shutter button.
- To return to the viewfinder image, press the <📷> button to exit Live View shooting. Then press the shutter button completely to take the picture.
- Setting the power switch to <OFF> or changing the shooting mode will revert the setting to **[Standard setting]**.



- The Live View image shown with the ambience setting applied will not exactly match the actual photo you take.
- Using flash may minimize the ambience effect.
- In bright outdoors, the Live View image you see on the screen might not exactly match the brightness or ambience in the actual photo you take. Set the **[🔦 LCD brightness]** menu to 4 and look at the Live View image while the screen is unaffected by outside light.



If you don't want the Live View image to be displayed when setting functions, press the <[Q]> button after step 1. When pressing the <[Q]> button, the Quick Control screen is displayed and you can shoot with the viewfinder after setting **[Shoot by ambience selection]** and **[Shoot by lighting or scene]**.

Ambience Settings

(1) **Standard setting**

Standard image characteristics for the respective shooting mode.

Note that <👤> has image characteristics geared for portraits and <🏞️> is geared for landscapes. Each ambience is a modification of the respective shooting mode's image characteristics.

(2) **Vivid**

The subject will look sharp and vivid. It makes the photo look more impressive than with [**Standard setting**].

(3) **Soft**

The subject will look softer and more dainty. Geared for portraits, pets, flowers, etc.

(4) **Warm**

The subject will look softer with warmer colors. Geared for portraits, pets, and other subjects you want give a warm look.

(5) **Intense**

While the overall brightness is slightly lowered, the subject is emphasized for a more intense feeling. Makes the human or living subject stand out more.

(6) **Cool**

The overall brightness is slightly lowered with a cooler color cast. A subject in the shade will look more calm and impressive.

(7) **Brighter**

The picture will look brighter.

(8) **Darker**

The picture will look darker.

(9) **Monochrome**

The picture will be monochrome. You can select the monochrome color to be black and white, sepia, or blue.

Shoot by Lighting or Scene Type

In the <👤> (Portrait), <🏞️> (Landscape), <🌸> (Close-up), and <🏊> (Sports) Basic Zone modes, you can shoot while the settings match the lighting or scene type. Normally, [Default setting] is adequate, but if the settings match the lighting condition or scene, the picture will look more accurate to your eye.

If you use this setting together with [Shoot by ambience selection] (p.68), you should set this first for better results.

Lighting or Scene			CA					
(1) Default setting	<input type="checkbox"/>	<input type="checkbox"/>	<input type="checkbox"/>	<input type="radio"/>	<input type="radio"/>	<input type="radio"/>	<input type="radio"/>	<input type="checkbox"/>
(2) Daylight	<input type="checkbox"/>	<input type="checkbox"/>	<input type="checkbox"/>	<input type="radio"/>	<input type="radio"/>	<input type="radio"/>	<input type="radio"/>	<input type="checkbox"/>
(3) Shade	<input type="checkbox"/>	<input type="checkbox"/>	<input type="checkbox"/>	<input type="radio"/>	<input type="radio"/>	<input type="radio"/>	<input type="radio"/>	<input type="checkbox"/>
(4) Cloudy	<input type="checkbox"/>	<input type="checkbox"/>	<input type="checkbox"/>	<input type="radio"/>	<input type="radio"/>	<input type="radio"/>	<input type="radio"/>	<input type="checkbox"/>
(5) Tungsten light	<input type="checkbox"/>	<input type="checkbox"/>	<input type="checkbox"/>	<input type="radio"/>	<input type="checkbox"/>	<input type="radio"/>	<input type="radio"/>	<input type="checkbox"/>
(6) Fluorescent light	<input type="checkbox"/>	<input type="checkbox"/>	<input type="checkbox"/>	<input type="radio"/>	<input type="checkbox"/>	<input type="radio"/>	<input type="radio"/>	<input type="checkbox"/>
(7) Sunset	<input type="checkbox"/>	<input type="checkbox"/>	<input type="checkbox"/>	<input type="radio"/>	<input type="radio"/>	<input type="radio"/>	<input type="radio"/>	<input type="checkbox"/>

- 1 Set the Mode Dial to any of the following modes: <👤> <🏞️> <🌸> <🏊>



- 2 Display the Live View image.
 - Press the <📷> button to switch to Live View shooting.



3 On the Quick Control screen, select the lighting or scene type.

- Press the <Q> button (10).
- Press the <▲▼> key to select [Default setting]. [Shoot by lighting or scene type] will appear on the screen's bottom.
- Press the <◀▶> key to select the lighting or scene type.
 - ▶ The LCD monitor will show how the image will look with the selected lighting or scene type.

4 Take the picture.

- To shoot while the Live View image is displayed, press the shutter button.
- To return to the viewfinder shooting, press the <📷> button to exit Live View shooting. Then press the shutter button completely to take the picture.
- Setting the power switch to <OFF> or changing the shooting mode will revert the setting to [Default setting].

- ⓘ ● If you use flash, [Default setting] will take effect.
- If you want to set this together with [Shoot by ambience selection], set the [Shoot by lighting or scene type] which best matches the ambience you have set. In the case of [Sunset] for example, warm colors will become prominent so the ambience you set might not work well. Before taking the picture, first check the Live View image to see how the picture will look.

Lighting or Scene Type Settings

(1) **Default setting**

The default setting.

(2) **Daylight**

For subjects under sunlight. Produces more natural-looking blue skies and greenery and reproduces light-colored flowers better.

(3) **Shade**

For subjects in the shade. Suitable for skin tones which may look too bluish or light-colored flowers.

(4) **Cloudy**

For subjects under overcast skies. Makes skin tones and landscapes, which may otherwise look dull on a cloudy day, look warmer. Also effective for light-colored flowers.

(5) **Tungsten light**

For subjects lit under tungsten lighting. Reduces the reddish-orange color cast caused by tungsten lighting.

(6) **Fluorescent light**

For subjects under fluorescent lighting. Suited for all types of fluorescent lighting.

(7) **Sunset**

Suitable when you want to capture the sunset's impressive colors.



3

Setting the AF and Drive Modes

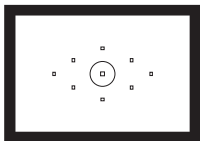

The viewfinder has nine AF points. By manually selecting a suitable AF point, you can shoot with autofocus while composing the shot as desired.

You can also select the AF mode and drive mode best matching the shooting conditions and subject.

- The ☆ icon on the upper right of the page title indicates that the function can be used only in Creative Zone modes (**P/ Tv/ Av/ M/ B**).
- In Basic Zone modes, the AF mode, AF point, and drive mode are set automatically.



<AF> stands for auto focus. <MF> stands for manual focus.

AF: Selecting the AF Mode ☆

You can select the AF mode suiting the shooting conditions or subject. In Basic Zone modes, the most suitable AF mode is set automatically.

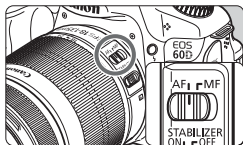

1 On the lens, set the focus mode switch to <AF>.

2 Set the Mode Dial to a Creative Zone mode.

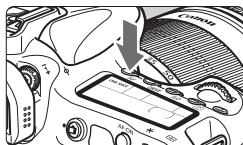

3 Press the <AF> button. (ⓘ6)

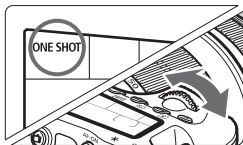

4 Select the AF mode.

- While looking at the LCD panel, turn the <⚙> or <⦿> dial.

ONE SHOT: One-Shot AF

AI FOCUS: AI Focus AF

AI SERVO: AI Servo AF

One-Shot AF for Still Subjects

Suited for still subjects. When you press the shutter button halfway, the camera will focus only once.

- When focus is achieved, the AF point which achieved focus will flash briefly in red, and the focus confirmation light <●> in the viewfinder will also light.
- With evaluative metering, the exposure setting will be set at the same time focus is achieved.
- While you hold down the shutter button halfway, the focus will be locked. You can then recompose the shot if desired.



- If focus cannot be achieved, the focus confirmation light <●> in the viewfinder will blink. If this occurs, a picture cannot be taken even if the shutter button is pressed completely. Recompose the picture and try to focus again. Or see “When Autofocus Fails” (p.80).
- If the [Beep] menu is set to [Disable], the beeper will not sound when focus is achieved.

AI Servo AF for Moving Subjects

This AF mode is for moving subjects when the focusing distance keeps changing. While you hold down the shutter button halfway, the subject will be focused continuously.

- The exposure is set at the moment the picture is taken.
- When the AF point selection (p.78) is automatic, the camera first uses the center AF point to focus. During autofocusing, if the subject moves away from the center AF point, focus tracking continues as long as the subject is covered by another AF point.



With AI Servo AF, the beeper will not sound even when focus is achieved. Also, the focus confirmation light <●> in the viewfinder will not light.

AI Focus AF for Automatic Switching of AF Mode

AI Focus AF switches the AF mode from One-Shot AF to AI Servo AF automatically if the still subject starts moving.

- After the subject is focused in the One-Shot AF mode, if the subject starts moving, the camera will detect the movement and change the AF mode automatically to AI Servo AF.



When focus is achieved in the AI Focus AF mode with the Servo mode active, the beeper will sound softly. However, the focus confirmation light <●> in the viewfinder will not light.

Selecting the AF Point ☆

Select one of the nine AF points to autofocus. Note that in Basic Zone modes, you cannot select the AF point since it is selected automatically.

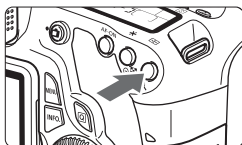

1 Press the button. (Ⓜ6)



- ▶ The selected AF point will be displayed in the viewfinder and on the LCD panel.
- When all AF points light up in the viewfinder, automatic AF point selection will be set.

2 Select the AF point.

- Pressing  toggles the AF point selection between the center AF point and automatic AF point selection.

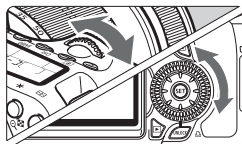

Selecting with the Dial

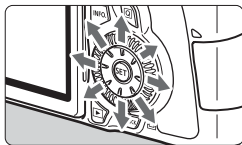

- When you turn the  or  dial, the AF point selection will change in the respective direction.
- When all AF points light up, automatic AF point selection will be set.

Selecting with the Multi-controller



- The AF point selection will change in the direction you tilt the . If you keep tilting  in the same direction, it will toggle between manual and automatic AF point selection.
- Press  to select the center AF point.



- If you prefer to look at the LCD panel while selecting the AF point, see the illustration below.

Automatic selection [- - - -], center [-],
right [-], top [-]

- When using an EOS-dedicated external Speedlite, if focus cannot be achieved with the AF-assist beam, select the center AF point.

AF-Assist Beam with the Built-in Flash

Under low-light conditions, when you press the shutter button halfway, the built-in flash fires a brief burst of flashes. It illuminates the subject to enable easier autofocus.



- The AF-assist beam will not be fired in the following shooting modes: .
- The built-in flash's AF-assist beam is effective up to approx. 4 meters/ 13.1 feet.
- In Creative Zone modes when you pop-up the built-in flash with the button, the AF-assist beam will be fired when necessary.

Lens' Maximum Aperture and AF Sensitivity

Maximum aperture: Up to f/5.6

With all AF points, cross-type AF sensitive to both vertical and horizontal lines is possible. Note that with certain lenses (p.309), the AF points other than the center AF point will be vertical-line or horizontal-line sensitive only (They will not work as cross-type points).

Maximum aperture: Up to f/2.8*

With the center AF point, high-precision, cross-type AF sensitive to both vertical and horizontal lines is possible. The center AF point's sensitivity to vertical and horizontal lines is about twice as sensitive as the other AF points.

The remaining eight AF points will work as cross-type points with f/5.6 and faster lenses.

* Except with the EF28-80mm f/2.8-4L USM and EF50mm f/2.5 Compact Macro lenses.

When Autofocus Fails

Autofocus can fail to achieve focus (the focus confirmation light <●> blinks) with certain subjects such as the following:

Subjects difficult to focus

- Very low-contrast subjects
(Example: Blue sky, solid-color walls, etc.)
- Subjects in very low light
- Extremely backlit or reflective subjects
(Example: Car with a highly reflective body, etc.)
- Near and far subjects covered by an AF point
(Example: Animal in a cage, etc.)
- Repetitive patterns
(Example: Skyscraper windows, computer keyboards, etc.)

In such cases, do one of the following:

- (1) With One-Shot AF, focus an object at the same distance as the subject and lock the focus before recomposing (p.56).
- (2) Set the lens focus mode switch to <MF> and focus manually.

MF: Manual Focusing

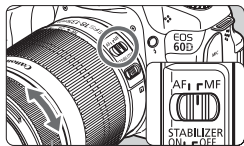

Focusing ring

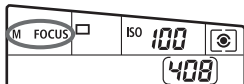

1 Set the lens focus mode switch to <MF>.

- ▶ <M FOCUS> will be displayed on the LCD panel.

2 Focus the subject.

- Focus by turning the lens focusing ring until the subject looks sharp in the viewfinder.

If you press the shutter button halfway during manual focusing, the AF point which achieved focus will flash briefly in red and the focus confirmation light <●> will light in the viewfinder.

Selecting the Drive Mode ☆

Single and continuous drive modes are provided. In the <□> (Full Auto) mode, single shooting is set automatically.

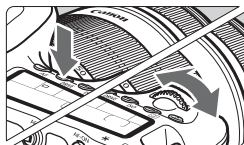

1 Press the <DRIVE> button. (ⓘ6)

2 Select the drive mode.

- While looking at the LCD panel, turn the <☀> or <⌚> dial.

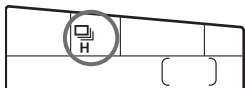

 : **Single shooting**

When you press the shutter button completely, only one shot will be taken.

 H : **High-speed continuous shooting** (Max. approx. 5.3 shots/sec.)

 : **Low-speed continuous shooting** (Max. approx. 3 shots/sec.)

While you hold down the shutter button completely, shots will be taken continuously.

 ⓘ ⓘ : **10-sec. self-timer/Remote control**

 ⓘ ⓘ₂ : **2-sec. self-timer/Remote control**

For self-timer shooting, see the next page. For remote control shooting, see page 126.



- In AI Servo AF mode, the continuous shooting speed may become slightly slower depending on the subject and the lens used.
- In low-light areas or indoors, the continuous shooting speed may become slower even if a fast shutter speed is set.

Using the Self-timer

Use the self-timer when you want to be in the picture. The  (10 sec. timer) can be used in all shooting modes.

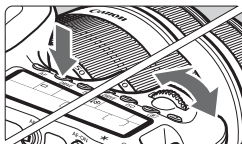

1 Press the <DRIVE> button. ()

2 Select the self-timer.

- While looking at the LCD panel, turn the  dial to select the self-timer.

 : 10-sec. self-timer

 : 2-sec. self-timer[★]

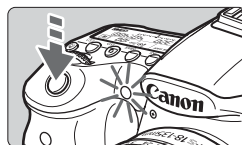
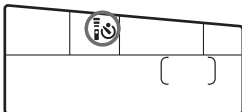

3 Take the picture.

- Look through the viewfinder, focus the subject, then press the shutter button completely.
- ▶ You can check the self-timer operation with the self-timer lamp, beeper, and countdown display (in seconds) on the LCD panel.
- ▶ Two seconds before the picture is taken, the self-timer lamp will stay on and the beeper will sound faster.

- The  2-sec. self-timer enables you to shoot while not touching the camera mounted on a tripod. This prevents camera shake while you shoot still lifes or bulb exposures.
- After taking self-timer shots, you should check the image for proper focus and exposure (p.190).
- If you will not look through the viewfinder when you press the shutter button, attach the eyepiece cover (p.124). If stray light enters the viewfinder when the picture is taken, it may throw off the exposure.
- When using the self-timer to shoot only yourself, use focus lock (p.56) on an object at about the same distance as where you will stand.
- To cancel the self-timer after it starts, press the <DRIVE> button.

4

Image Settings

This chapter explains image-related function settings: Image-recording quality, ISO speed, Picture Style, white balance, Auto Lighting Optimizer, lens peripheral illumination correction, etc.

- In Basic Zone modes, only the following can be set as described in this chapter: Image-recording quality, lens peripheral illumination correction, folder creation and selection, and image file numbering.
- The ☆ icon on the upper right of the page title indicates that the function can be used only in Creative Zone modes (**P/ Tv/ Av/ M/ B**).

MENU Setting the Image-recording Quality

You can select the pixel count and the image quality. There are eight JPEG image quality settings: **L**/**L**/**M**/**M**/**S1**/**S1**/**S2**/**S3**.

There are three RAW image quality settings: **RAW**, **M RAW**, **S RAW** (p.86)



1 Select [Quality].

- Under the [Q] tab, select [Quality], then press <SET>.

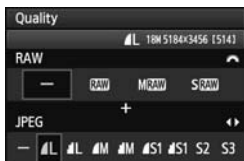

2 Select the image-recording quality.

- To select a RAW setting, turn the <DIAL> dial. To select a JPEG setting, press the <LEFT> key.
- On the upper right, the “****M (megapixels) **** x ****” number indicates the recorded pixel count, and [***] is the number of possible shots (displayed up to 999).
- Press <SET> to set it.

Image-recording Quality Setting Examples

L only



RAW only



RAW + **L**



S RAW + **M**

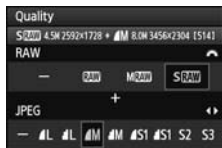

* If [-] is set for both RAW and JPEG, **L** will be set.

Guide to Image-recording Quality Settings (Approx.)



Quality		Pixels Recorded (megapixels)	Printing Size	File Size (MB)	Possible Shots	Maximum Burst
JPEG	L	Approx. 17.9 (17.9M)	A2 or larger	6.4	570	58
	L			3.2	1120	300
	M	Approx. 8.0 (8M)	Around A3	3.4	1070	260
	M			1.7	2100	2100
	S1	Approx. 4.5 (4.5M)	Around A4	2.2	1670	1670
	S1			1.1	3180	3180
	S2 ^{*1}	Approx. 2.5 (2.5M)	Around 9x13cm	1.3	2780	2780
	S3 ^{*2}	Approx. 0.35 (0.35M)	—	0.3	10780	10780
RAW	RAW	Approx. 17.9 (17.9M)	A2 or larger	24.5	150	16
	M RAW	Approx. 10.1 (10M)	Around A3	16.7	220	19
	S RAW	Approx. 4.5 (4.5M)	Around A4	11.1	340	24
RAW + JPEG	RAW L	Approx. 17.9 Approx. 17.9	A2 or larger A2 or larger	24.5+6.4	110	7
	M RAW L	Approx. 10.1 Approx. 17.9	Around A3 A2 or larger	16.7+6.4	160	7
	S RAW L	Approx. 4.5 Approx. 17.9	Around A4 A2 or larger	11.1+6.4	210	7

*1: S2 is suitable for playing the images on a digital photo frame.

*2: S3 is suitable for emailing the image or using it on a Web site.

- S2 and S3 will be in (Fine) quality.
- Figures for the file size, possible shots, and maximum burst during continuous shooting are based on Canon's testing standards (3:2 aspect ratio, ISO 100 and Standard Picture Style) using a 4GB card. **These figures will vary depending on the subject, card brand, aspect ratio, ISO speed, Picture Style, Custom Functions, and other settings.**
- The maximum burst applies to high-speed continuous shooting.

 If the image's aspect ratio is different from the printing paper's aspect ratio, the image may be cropped significantly if you print it as a borderless print. If the image is cropped, it may look more grainy on the paper due to the fewer number of pixels.

- 
- If you select both RAW and JPEG, the same image will be recorded simultaneously to the card in both file types at the selected image-recording quality. The two images will be saved in the same folder with the same file numbers (file extension .JPG for JPEG and .CR2 for RAW).
 - The image-recording quality settings are named as follows: **RAW** (RAW), **M RAW** (Medium RAW), **S RAW** (Small RAW), JPEG,  (Fine),  (Normal), **L** (Large), **M** (Medium), **S** (Small).

About RAW

A RAW image is raw data output by the image sensor converted to digital data. It is recorded to the card as is, and you can select the quality as follows: **RAW**, **M RAW**, or **S RAW**.

A **RAW** image can be processed with the [] **RAW image processing** menu (p.224) and saved as a JPEG image. (**M RAW** and **S RAW** images cannot be processed with the camera.) While the RAW image itself does not change, you can process the RAW image according to different conditions to create any number of JPEG images from it. With all RAW images, you can use the provided software to make various adjustments and then generate a JPEG, TIFF, etc., image incorporating those adjustments.

 Commercially-available software might not be able to display RAW images. Using the provided software is recommended.

Maximum Burst During Continuous Shooting

The maximum burst during continuous shooting indicated on page 85 is the number of continuous shots that can be taken without stopping, based on a formatted 4GB card.



The number is displayed on the bottom right in the viewfinder. If the maximum burst is 99 or higher, “99” will be displayed.

- The maximum burst is displayed even when a card is not inserted in the camera. Make sure that a card is loaded before taking a picture.
- If [**C.Fn II -2: High ISO speed noise reduction**] is set to [**2: Strong**], the maximum burst will be greatly reduced (p.254).

If the viewfinder displays “99” for the maximum burst, it means the maximum burst is 99 or higher. If the maximum burst decreases to 98 or lower and the internal buffer memory becomes full, “**buSY**” will be displayed in the viewfinder and on the LCD panel. Shooting will then be disabled temporarily. If you stop the continuous shooting, the maximum burst will increase. After all the captured images are written to the card, the maximum burst will be as listed on page 85.

ISO: Setting the ISO Speed ☆

Set the ISO speed (image sensor's sensitivity to light) to suit the ambient light level. In Basic Zone modes, the ISO speed is set automatically (p.89).

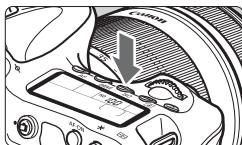

1 Press the <ISO> button. (⚙6)

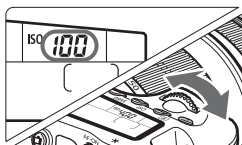

2 Set the ISO speed.

- While looking at the LCD panel or viewfinder, turn the <⚙> or <⌚> dial.
- It can be set within ISO 100-6400 in 1/3-stop increments.
- With “A” selected, the ISO speed will be set automatically (p.89).

ISO Speed Guide

ISO Speed	Shooting Situation (No flash)	Flash Range
100 - 400	Sunny outdoors	The higher the ISO speed, the farther the flash range will extend (p.131).
400 - 1600	Overcast skies or evening time	
1600 - 6400, H	Dark indoors or night	

* High ISO speeds will result in grainy images.

- If [**C.Fn II -3: Highlight tone priority**] is set to [**1: Enable**], ISO 100/125/160 and “H” (equivalent to ISO 12800) cannot be set (p.255).
- Shooting in high temperatures may result in grainy pictures. Long exposures can also cause irregular colors in the image.
- When you shoot at high ISO speeds, noise (banding, dots of light, etc.) may become noticeable.

With [**C.Fn I -3: ISO expansion**] set to [**1: On**], “H” (equivalent to ISO 12800) can also be set (p.252).

About “A” (Auto) ISO Speed

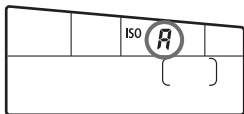

If the ISO speed is set to “A”, the actual ISO speed to be set will be displayed when you press the shutter button halfway. As indicated below, the ISO speed will be set automatically to suit the shooting mode.

Shooting Mode	ISO Speed Setting
	Automatically set within ISO 100 - 3200
P/Tv/Av/M	Automatically set within ISO 100 - 6400 ^{*1}
	Fixed at ISO 100
B	Fixed at ISO 400
With flash	Fixed at ISO 400 ^{*2*3}

*1: Depending on the maximum ISO speed that has been set.

*2: If fill flash results in overexposure, ISO 100 or a higher ISO will be set.

*3: In the <P> and Basic Zone modes (except <F>), ISO 400 - 1600 will be set automatically if bounce flash is used with an external Speedlite. If the maximum ISO speed has been set to [400] or [800], the ISO speed will be set within this limit.

MENU Setting the Maximum ISO Speed for Auto ISO [★]

For Auto ISO, you can set the maximum ISO speed within ISO 400 - 6400. If you want better image quality with less noise, set the maximum ISO speed to 400, 800, or 1600. If you will shoot in low light and want to avoid using a slow shutter speed, set the maximum ISO speed to 3200 or 6400.



Under the [ISO] tab, select [ISO Auto], then press <SET>. Select the ISO speed, then press <SET>.



Selecting a Picture Style ☆

By selecting a Picture Style, you can obtain image effects matching your photographic expression or the subject.

In Basic Zone modes, you cannot select the Picture Style.



1 Select [Picture Style].

- Under the [] tab, select [Picture Style], then press <  >.
- ▶ The Picture Style selection screen will appear.



2 Select a Picture Style.

- Select a Picture Style, then press <  >.
- ▶ The Picture Style will be set and the menu reappears.

Picture Style Effects

Standard

The image looks vivid, sharp, and crisp. This is a general-purpose Picture Style suitable for most scenes.

Portrait

For nice skin tones. The image looks softer. Effective for close-ups of people. This Picture Style is also selected automatically when the Mode Dial is set to <  >.

By changing the [Color tone] (p.92), you can adjust the skin tone.

Landscape

For vivid blues and greens, and very sharp and crisp images. Effective for impressive landscapes. This Picture Style is also selected automatically when the Mode Dial is set to <  >.

Neutral

This Picture Style is for users who prefer to process images with their computer. For natural colors and subdued images.

Faithful

This Picture Style is for users who prefer to process images with their computer. When the subject is captured under a daylight color temperature of 5200K, the color is adjusted colorimetrically to match the subject's color. The image is dull and subdued.

Monochrome

Creates black-and-white images.

 Black-and-white images shot in JPEG cannot be reverted to color. If you want to later shoot pictures in color, make sure the **[Monochrome]** setting has been canceled. When **[Monochrome]** is selected, **<B/W>** will appear in the viewfinder and on the LCD panel.

User Def. 1-3

You can register a basic style such as **[Portrait]**, **[Landscape]**, a Picture Style file, etc., and adjust it as desired (p.94). Any User Defined Picture Style which has not been set will have the same settings as the Standard Picture Style.







About the Symbols

The symbols on the upper right of the Picture Style selection screen refer to parameters such as **[Sharpness]** and **[Contrast]**. The numerals indicate the parameter settings, such as for **[Sharpness]** and **[Contrast]**, for each Picture Style.

Picture Style				
 Standard	3	0	0	0
 Portrait	2	0	0	0
 Landscape	4	0	0	0

Picture Style				
 Landscape	4	0	0	0
 Neutral	0	0	0	0
 Faithful	0	0	0	0
 Monochrome	3	0	N	N
 User Def. 1	Standard			
 User Def. 2	Standard			

Symbols

	Sharpness
	Contrast
	Saturation
	Color tone
	Filter effect (Monochrome)
	Toning effect (Monochrome)

Customizing a Picture Style ☆

You can customize a Picture Style by adjusting individual parameters like **[Sharpness]** and **[Contrast]**. To see the resulting effects, take test shots. To customize **[Monochrome]**, see the next page.



1 Select [Picture Style].

- Under the [P] tab, select **[Picture Style]**, then press <SET>.
- ▶ The Picture Style selection screen will appear.

2 Select a Picture Style.

- Select a Picture Style, then press the <INFO,> button.



3 Select a parameter.

- Select a parameter such as **[Sharpness]**, then press <SET>.



4 Set the parameter.

- Press the <◀▶> key to adjust the parameter as desired, then press <SET>.
- Press the <MENU> button to save the adjusted parameters. The Picture Style selection screen will reappear.
- ▶ Any settings different from the default will be displayed in blue.



Parameter Settings and Effects

Sharpness	0: Less sharp outline	+7: Sharp outline
Contrast	-4: Low contrast	+4: High contrast
Saturation	-4: Low saturation	+4: High saturation
Color tone	-4: Reddish skin tone	+4: Yellowish skin tone



- By selecting [**Default set.**] in step 3, you can revert the respective Picture Style to its default parameter settings.
- To shoot with the Picture Style you modified, follow step 2 on the preceding page to select the modified Picture Style and then shoot.

Monochrome Adjustment

For Monochrome, you can also set [**Filter effect**] and [**Toning effect**] in addition to [**Sharpness**] and [**Contrast**] explained on the preceding page.

Filter Effect



With a filter effect applied to a monochrome image, you can make white clouds or green trees stand out more.

Filter	Sample Effects
N: None	Normal black-and-white image with no filter effects.
Ye: Yellow	The blue sky will look more natural, and the white clouds will look crisper.
Or: Orange	The blue sky will look slightly darker. The sunset will look more brilliant.
R: Red	The blue sky will look quite dark. Fall leaves will look crisper and brighter.
G: Green	Skin tones and lips will look fine. Tree leaves will look crisper and brighter.



Increasing the [**Contrast**] will make the filter effect more pronounced.

Toning Effect

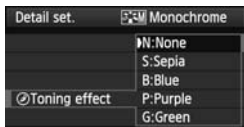

By applying a toning effect, you can create a monochrome image in that color. It can make the image look more impressive.

The following can be selected: [**N:None**] [**S:Sepia**] [**B:Blue**] [**P:Purple**] [**G:Green**].

🔧 Registering a Picture Style ☆

You can select a base Picture Style such as [Portrait] or [Landscape], adjust its parameters as desired and register it under [User Def. 1], [User Def. 2], or [User Def. 3].

You can create Picture Styles whose parameter settings such as for sharpness and contrast are different. You can also adjust the parameters of a Picture Style which has been registered to the camera with the provided software.

1 Select [Picture Style].

- Under the [P] tab, select [Picture Style], then press <SET>.
- ▶ The Picture Style selection screen will appear.



2 Select [User Def.].

- Select [User Def. *], then press the <INFO,> button.

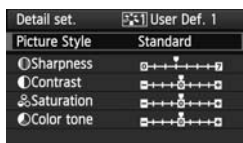

3 Press <SET>.

- With [Picture Style] selected, press <SET>.

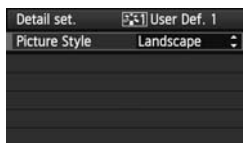

4 Select the base Picture Style.

- Press the <▲▼> key to select the base Picture Style, then press <SET>.
- To adjust the parameters of a Picture Style which has been registered to the camera with the provided software, select the Picture Style here.

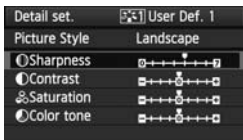

5 Select a parameter.

- Select a parameter such as **[Sharpness]**, then press **<SET>**.

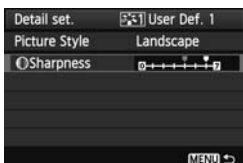

6 Set the parameter.

- Press the **<◀▶>** key to adjust the parameter as desired, then press **<SET>**. For details, see “Customizing a Picture Style” on pages 92-93.



- Press the **<MENU>** button to register the new Picture Style. The Picture Style selection screen will then reappear.
 - ▶ The base Picture Style will be indicated on the right of **[User Def. *]**.
 - ▶ The name of the Picture Style having any modified settings (different from the default) registered under **[User Def. *]** will be displayed in blue.



- If a Picture Style has already been registered under **[User Def. *]**, changing the base Picture Style in step 4 will cancel the parameter settings of the registered Picture Style.
- If you execute **[Clear all camera settings]** (p.51), all the **[User Def. *]** settings will revert to the default.



To shoot with the registered Picture Style, follow step 2 on the preceding page to select **[User Def. *]** and then shoot.

MENU Setting the White Balance ☆

White balance (WB) is for making the white areas look white. Normally, the <AWB> (Auto) setting will obtain the correct white balance. If natural-looking colors cannot be obtained with <AWB>, you can select the white balance to match the light source or set it manually by shooting a white object.



1 Select [White balance].

- Under the [AWB] tab, select [White balance], then press <SET>.

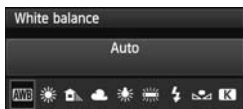

2 Select the white balance.

- Select the white balance, then press <SET>.

Display	Mode	Color Temperature (Approx. K: Kelvin)
AWB	Auto	3000 - 7000
☀	Daylight	5200
🏠	Shade	7000
☁	Cloudy, twilight, sunset	6000
💡	Tungsten light	3200
💡	White fluorescent light	4000
⚡	Flash use	Automatically set*
📷	Custom (p.97)	2000 - 10000
K	Color temperature (p.98)	2500 - 10000

* Applicable with Speedlites having a color temperature transmission function. Otherwise, it will be set to approx. 6000K.

About White Balance

To the human eye, a white object looks white regardless of the type of lighting. With a digital camera, the color temperature is adjusted with software to make the white areas look white. This adjustment serves as the basis for the color correction. The result is natural-looking colors in the pictures.

Custom White Balance

Custom white balance enables you to manually set the white balance for a specific light source for better accuracy. Do this procedure under the actual light source to be used.

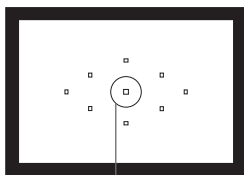

Spot metering circle

1 Photograph a white object.

- The plain, white object should fill the spot metering circle.
- Focus manually and set the standard exposure for the white object.
- You can set any white balance.

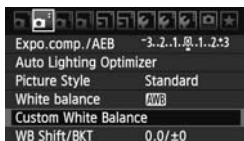

2 Select [Custom White Balance].

- Under the [M] tab, select [Custom White Balance], then press <SET>.
- ▶ The custom white balance selection screen will appear.

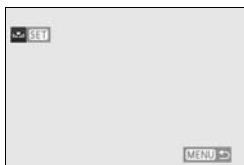

3 Import the white balance data.

- Turn the <DISP> dial to select the image captured in step 1, then press <SET>.
- ▶ On the dialog screen which appears, select [OK] and the data will be imported.
- When the menu reappears, press the <MENU> button to exit the menu.

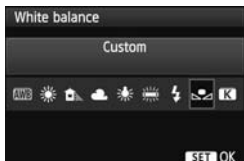

4 Select [White balance].

- Under the [M] tab, select [White balance], then press <SET>.

5 Select the custom white balance.

- Select [M], then press <SET>.

- If the exposure obtained in step 1 is way off, a correct white balance might not be obtained.
- If the image was captured while the Picture Style was set to **[Monochrome]** (p.91) or if a Creative filter has been applied to the image (p.220), it cannot be selected in step 3.

- Instead of a white object, an 18% gray card (commercially available) can produce a more accurate white balance.
- The personal white balance registered with the provided software will be registered under [☑]. If you do step 3, the data for the registered personal white balance will be erased.

[K] Setting the Color Temperature

You can set the white balance's color temperature numerically in Kelvin. This is for advanced users.

1 Select **[White balance]**.

- Under the [☑] tab, select **[White balance]**, then press < (SET) >.

2 Set the color temperature.

- Select **[K]**.
- Turn the < (DIAL) > dial to set the color temperature, then press < (SET) >.
- The color temperature can be set from approx. 2500K to 10000K in 100K increments.

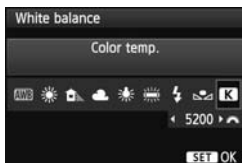

- When setting the color temperature for an artificial light source, set white balance correction (magenta or green) as necessary.
- If you want to set **[K]** to the reading taken with a commercially-available color temperature meter, take test shots and adjust the setting to compensate for the difference between the color temperature meter's reading and the camera's color temperature reading.

WB White Balance Correction ☆

You can correct the white balance that has been set. This adjustment will have the same effect as using a commercially-available color temperature conversion filter or color compensating filter. Each color can be corrected to one of nine levels.

This is for advanced users who are familiar with using color temperature conversion or color compensating filters.

White Balance Correction

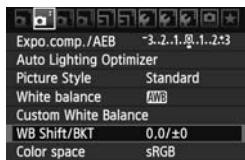

1 Select [WB Shift/BKT].

- Under the [WB] tab, select [WB Shift/BKT], then press <SET>.

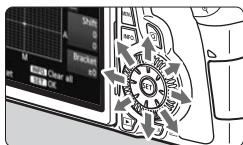

2 Set the white balance correction.

- Use <▲> to move the “WB” mark to the desired position.
- B is for blue, A is amber, M is magenta, and G is green. The color in the respective direction will be corrected.
- On the upper right, “Shift” indicates the direction and correction amount.
- Pressing the <INFO.> button will cancel all the [WB Shift/BKT] settings.
- Press <SET> to exit the setting and return to the menu.

Sample setting: A2, G1

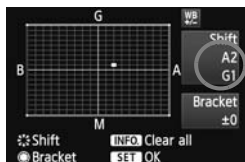

- During the white balance correction, <WB> will be displayed in the viewfinder and on the LCD panel.
- One level of the blue/amber correction is equivalent to 5 mireds of a color temperature conversion filter. (Mired: Measuring unit indicating the density of a color temperature conversion filter.)

White Balance Auto Bracketing

With just one shot, three images having a different color balance can be recorded simultaneously. Based on the color temperature of the current white balance setting, the image will be bracketed with a blue/amber bias or magenta/green bias. This is called white balance bracketing (WB-BKT). White balance bracketing is possible up to ± 3 levels in single-level increments.

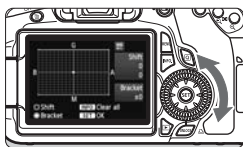

B/A bias ± 3 levels

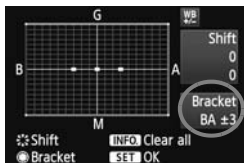

Set the white balance bracketing amount.

- In step 2 for white balance correction, when you turn the $\langle \odot \rangle$ dial, the "■" mark on the screen will change to "■■■" (3 points). Turning the dial to the right sets the B/A bracketing, and turning it to the left sets the M/G bracketing.
- ▶ On the right, "**Bracket**" indicates the bracketing direction and correction amount.
- Pressing the $\langle \text{INFO.} \rangle$ button will cancel all the [WB Shift/BKT] settings.
- Press $\langle \text{SET} \rangle$ to exit the setting and return to the menu.

Bracketing Sequence

The images will be bracketed in the following sequence: 1. Standard white balance, 2. Blue (B) bias, and 3. Amber (A) bias, or 1. Standard white balance, 2. Magenta (M) bias, and 3. Green (G) bias.



- During WB bracketing, the maximum burst for continuous shooting will be lower and the number of possible shots will also decrease to one-third the normal number.
- You can also set white balance correction and AEB together with white balance bracketing. If you set AEB in combination with white balance bracketing, a total of nine images will be recorded for a single shot.
- Since three images are recorded for one shot, the card will take longer to record the shot.
- "**BKT**" stands for Bracketing.

MENU Auto Lighting Optimizer ☆

If the image comes out dark or the contrast is low, the brightness and contrast can be corrected automatically. The default setting is [Standard]. With JPEG images, the correction is done when the image is captured.



1 Select [Auto Lighting Optimizer].

- Under the [☑] tab, select [Auto Lighting Optimizer], then press <SET>.

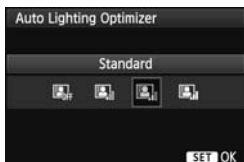

2 Set the correction setting.

- Select the desired setting, then press <SET>.

3 Take the picture.

- The image will be recorded with the brightness and contrast corrected if necessary.



Without correction



With correction



- If [☑] **C.Fn II -3: Highlight tone priority** is set to [1: Enable], the Auto Lighting Optimizer will be set automatically to [Disable] and you cannot change this setting.
- Depending on the shooting conditions, noise might increase.
- If a setting other than [Disable] is set and you use exposure compensation, flash exposure compensation, or manual exposure to darken the exposure, the image might still come out bright. If you want a darker exposure, set this to [Disable] first.



In Basic Zone modes, [Standard] is set automatically.

MENU Lens Peripheral Illumination Correction

Due to the lens characteristics, the four corners of the picture might look darker. This is called lens light fall-off or drop in peripheral illumination. The default setting is **[Enable]**.

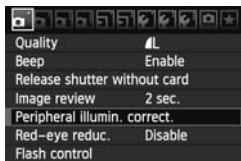

1 Select **[Peripheral illumin. correct.]**.

- Under the [] tab, select **[Peripheral illumin. correct.]**, then press <SET>.

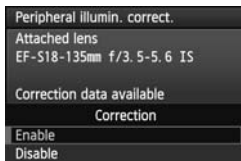

2 Set the correction setting.

- On the screen, check that the attached lens' **[Correction data available]** is displayed.
- If **[Correction data not available]** is displayed, see "About the Lens Correction Data" on the next page.
- Select **[Enable]**, then press <SET>.

3 Take the picture.

- The image will be recorded with the corrected peripheral illumination.



Without correction



With correction

About the Lens Correction Data

The camera already contains lens peripheral illumination correction data for about 25 lenses. In step 2, if you select **[Enable]**, the peripheral light correction will be applied automatically for any lens whose correction data has been registered in the camera.

With EOS Utility (provided software), you can check which lenses have their correction data registered in the camera. You can also register the correction data for unregistered lenses. For details, see the Software Instruction Manual (CD-ROM) for EOS Utility.



- For JPEG images already captured, lens peripheral illumination correction cannot be applied.
- Depending on shooting conditions, noise might appear on the image periphery.
- When using a non-Canon lens, setting the correction to **[Disable]** is recommended, even if **[Correction data available]** is displayed.



- Lens peripheral light correction is applied even when an Extender is attached.
- If the correction data for the attached lens has not been registered to the camera, the result will be the same as when the correction is set to **[Disable]**.
- The correction amount applied will be slightly lower than the maximum correction amount settable with Digital Photo Professional (provided software).
- If the lens does not have distance information, the correction amount will be lower.
- The higher the ISO speed, the lower the correction amount will be.

MENU Creating and Selecting a Folder

You can freely create and select the folder where the captured images are to be saved.

This is optional since a folder will be created automatically for saving captured images.

Create a Folder



1 Select [Select folder].

- Under the [**F**] tab, select [**Select folder**], then press < **SET** >.

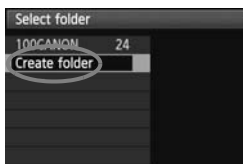

2 Select [Create folder].

- Select [**Create folder**], then press < **SET** >.

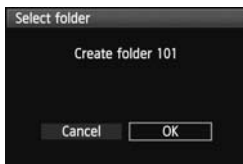

3 Create a new folder.

- Select [**OK**], then press < **SET** >.
- ▶ A new folder with a higher one-up folder number is created.

Selecting a Folder

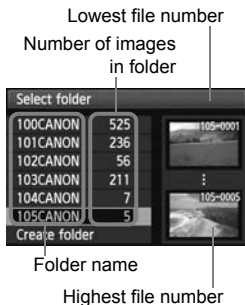

- With the folder selection screen displayed, select a folder and press $\langle \text{SET} \rangle$.
- ▶ The folder where the captured images will be saved is selected.
- Subsequent captured images will be recorded into the selected folder.

About Folders

As with “100CANON” for example, the folder name starts with three digits (folder number) followed by five alphanumeric characters. A folder can contain up to 9999 images (file No. 0001 - 9999). When a folder becomes full, a new folder with a higher one-up folder number is created automatically. Also, if manual reset (p.107) is executed, a new folder will be created automatically. Folders numbered from 100 to 999 can be created.

Creating Folders with a Personal Computer

With the card open on the screen, create a new folder named “DCIM”. Open the DCIM folder and create as many folders as necessary to save and organize your images. The folder name must follow the “100ABC_D” format where the first three digits is 100 - 999 followed by five alphanumeric characters. The five characters can be a combination of upper- or lower-case letters from A to Z, numerals, and an underscore “_”. There can be no space in the folder name. Also, folder names cannot have the same three-digit number such as “100ABC_D” and “100W_XYZ” even if the letters are different.

MENU File Numbering Methods

The file number is like the frame number on a roll of film. The captured images are assigned a sequential file number from 0001 to 9999 and saved in one folder. You can change how the file number is assigned. The file number will appear on your computer in this format:

IMG_0001.JPG.

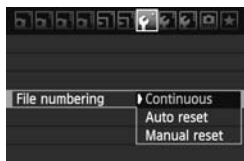

1 Select [File numbering].

- Under the [F] tab, select [File numbering], then press <SET>.

2 Select the file numbering method.

- Select the desired setting, then press <SET>.

Continuous

Continues the file numbering sequence even after the card is replaced or a new folder is created.

Even after you replace the card or create a new folder, the file numbering continues in sequence up to 9999. This is convenient when you want to save images numbered anywhere between 0001 to 9999 in multiple cards or folders into one folder in your personal computer. If the replacement card or existing folder already contains images recorded previously, the file numbering of the new images might continue from the file numbering of the existing images in the card or folder. If you want to use continuous file numbering, you should use a newly-formatted card each time.

File numbering after replacing the card

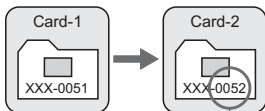

Next sequential file number

File numbering after creating a folder

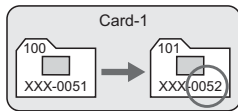

Auto Reset

The file numbering restarts from 0001 each time the card is replaced or a new folder is created.

Whenever the card is replaced or a new folder created, the file numbering starts from 0001. This is convenient if you want to organize images according to cards or folders. If the replacement card or existing folder already contains images recorded previously, the file numbering of the new images might continue from the file numbering of the existing images in the card or folder. If you want to save images with the file numbering starting from 0001, use a newly formatted card each time.

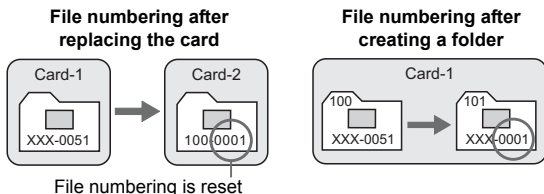

Manual Reset

To reset the file numbering to 0001 or to start from file number 0001 in a new folder.

When you reset the file numbering manually, a new folder is created automatically and the file numbering of images saved to that folder starts from 0001. This is convenient if you want to use different folders for the images taken yesterday and the ones taken today, for example. After the manual reset, the file numbering returns to continuous or auto reset.

 If the file number in folder No. 999 reaches 9999, shooting will not be possible even if the card still has storage capacity. The LCD monitor will display a message telling you to replace the card. Replace it with a new card.

 For both JPEG and RAW images, the file name will start with "IMG_". Movie file names will start with "MVI_". The extension will be ".JPG" for JPEG images, ".CR2" for RAW images, and ".MOV" for movies.

MENU Setting Copyright Information ☆

When you set the copyright information, it will be appended to the image as Exif information.



1 Select [Copyright information].

- Under the [F:] tab, select [Copyright information], then press <SET>.



2 Select the desired option.

- Select [Enter author's name] or [Enter copyright details], then press <SET>.
- ▶ The text entry screen will appear.
- Select [Display copyright info.] to check the copyright information currently set.
- Select [Delete copyright information] to delete the copyright information currently set.



3 Enter text.

- Refer to "Text Entry Procedure" on the next page and enter the copyright information.
- Enter up to 63 alphanumeric characters and symbols.

4 Exit the setting.

- After entering the text, press the <MENU> button to exit.

Text Entry Procedure



- **Changing the entry area**
Press the <Q> button to toggle between the top and bottom entry areas.
- **Moving the cursor**
Press the <◀▶> key to move the cursor.
- **Entering text**
In the bottom area, press the <▲▼> or <◀▶> key to select a character, then press <SET> to enter it.
- **Deleting a character**
Press the <⏏> button to delete a character.
- **Exiting**
After entering the text, press the <MENU> button to finalize the text entry and return to the screen in step 2.
- **Canceling the text entry**
To cancel the text entry, press the <INFO.> button to cancel it and return to the screen in step 2.



You can also enter the copyright information with EOS Utility (provided software).

MENU Setting the Color Space ☆

The color space refers to the range of reproducible colors. With this camera, you can set the color space for captured images to sRGB or Adobe RGB. For normal shooting, sRGB is recommended. In Basic Zone modes, sRGB is set automatically.

1 Select [Color space].

- Under the [] tab, select [Color space], then press <SET>.

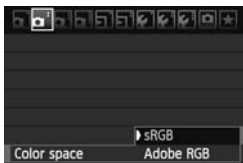

2 Set the desired color space.

- Select [sRGB] or [Adobe RGB], then press <SET>.

About Adobe RGB

This color space is mainly used for commercial printing and other industrial uses. This setting is not recommended if you do not know about image processing, Adobe RGB, and Design rule for Camera File System 2.0 (Exif 2.21). The image will look very subdued in a sRGB personal computer environment and with printers not compatible with Design rule for Camera File System 2.0 (Exif 2.21). Post-processing of the image with software will therefore be required.



- If the image is captured with the color space set to Adobe RGB, the file name will start with “_MG_” (first character is an underscore).
- The ICC profile is not appended. See explanations about the ICC profile in the Software Instruction Manual in the CD-ROM.

5

Advanced Operations

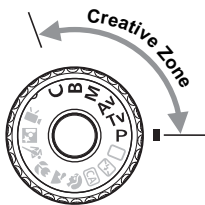

In Creative Zone modes, you can set the shutter speed and/or aperture to set the exposure as desired. By changing the camera settings, you can obtain various results.

- The ☆ icon on the upper right of the page title indicates that the function can be used only in Creative Zone modes (**P/ Tv/ Av/ M/ B**).
- After you press the shutter button halfway and let go, the LCD panel and viewfinder information will remain displayed for approx. 4 sec. (ⓘ4).
- Settable functions in Creative Zone modes are listed in “Function Availability Table According to Shooting Modes” on page 276.

P: Program AE

The camera automatically sets the shutter speed and aperture to suit the subject's brightness. This is called Program AE.

* <P> stands for Program.

* AE stands for Auto Exposure.



1 Set the Mode Dial to <P>.



2 Focus the subject.

- Look through the viewfinder and aim the selected AF point over the subject. Then press the shutter button halfway.
- ▶ The AF point which achieves focus flashes in red, and the focus confirmation light <●> in the viewfinder's bottom right lights (with One Shot AF).
- ▶ The shutter speed and aperture will be set automatically and displayed in the viewfinder and on the LCD panel.



3 Check the display.

- A standard exposure will be obtained as long as the shutter speed and aperture display do not blink.

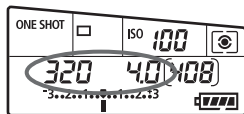

4 Take the picture.

- Compose the shot and press the shutter button completely.

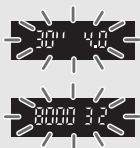

- If the "30'" shutter speed and the maximum aperture blink, it indicates underexposure. Increase the ISO speed or use flash.
- If the "8000" shutter speed and the minimum aperture blink, it indicates overexposure. Lower the ISO speed or use an ND filter (sold separately) to reduce the amount of light entering the lens.



Differences Between <P> and <□> (Full Auto)

With <□>, many functions such as the AF mode, drive mode, and built-in flash are set automatically to prevent spoiled shots. The functions you can set are limited. With <P>, only the shutter speed and aperture are set automatically. You can freely set the AF mode, drive mode, built-in flash, and other functions (p.276).

About Program Shift

- In the Program AE mode, you can freely change the shutter speed and aperture combination (Program) set automatically by the camera while maintaining the same exposure. This is called Program shift.
- To do this, press the shutter button down halfway, then turn the <☀> dial until the desired shutter speed or aperture is displayed.
- Program shift is canceled automatically after the picture is taken.
- Program shift cannot be used with flash.

Tv: Shutter-Priority AE

In this mode, you set the shutter speed and the camera automatically sets the aperture to obtain the standard exposure suiting the brightness of the subject. This is called shutter-priority AE. A faster shutter speed can freeze the action or moving subject. Or a slower shutter speed can create a blurred effect, giving the impression of motion.

* <Tv> stands for Time value.



Frozen action
(Fast shutter speed: 1/2000 sec.)



Blurred motion
(Slow shutter speed: 1/30 sec.)



1 Set the Mode Dial to <Tv>.

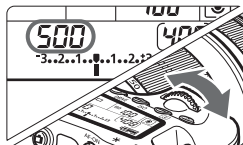

2 Set the desired shutter speed.

- While looking at the LCD panel, turn the <gear> dial.

3 Focus the subject.

- Press the shutter button halfway.
- ▶ The aperture is set automatically.



4 Check the viewfinder display and shoot.

- As long as the aperture is not blinking, the exposure will be standard.



- If the maximum aperture blinks, it indicates underexposure. Turn the  dial to set a slower shutter speed until the aperture stops blinking or set a higher ISO speed.



- If the minimum aperture blinks, it indicates overexposure. Turn the  dial to set a faster shutter speed until the aperture stops blinking or set a lower ISO speed.



Shutter Speed Display

The shutter speeds from “8000” to “4” indicate the denominator of the fractional shutter speed. For example, “125” indicates 1/125 sec. Also, “0”5” indicates 0.5 sec. and “15”” is 15 sec.

Av: Aperture-Priority AE

In this mode, you set the desired aperture and the camera sets the shutter speed automatically to obtain the standard exposure suiting the subject brightness. This is called aperture-priority AE. A higher f/number (smaller aperture hole) will make more of the foreground and background fall within acceptable focus. On the other hand, a lower f/number (larger aperture hole) will make less of the foreground and background fall within acceptable focus.

* <Av> stands for Aperture value (aperture opening).



Sharp foreground and background
(With a high aperture f/number: f/32)



Blurred background
(With a low aperture f/number: f/5.6)



1 Set the Mode Dial to <Av>.

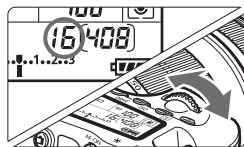

2 Set the desired aperture.

- While looking at the LCD panel, turn the <Av> dial.

3 Focus the subject.

- Press the shutter button halfway.
- ▶ The shutter speed is set automatically.



4 Check the viewfinder display and shoot.

- As long as the shutter speed is not blinking, the exposure will be standard.



- If the “30” shutter speed blinks, it indicates underexposure. Turn the dial to set a larger aperture (smaller f/number) until the blinking stops or set a higher ISO speed.



- If the “8000” shutter speed blinks, it indicates overexposure. Turn the dial to set a smaller aperture (larger f/number) until the blinking stops or set a lower ISO speed.



Aperture Display

The higher the f/number, the smaller the aperture opening will be. The apertures displayed will differ depending on the lens. If no lens is attached to the camera, “00” will be displayed for the aperture.

Depth of Field Preview ☆

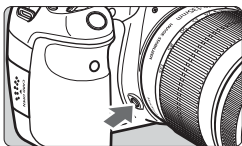

Press the depth-of-field preview button to stop down the lens to the current aperture setting. You can check the depth of field (range of acceptable focus) through the viewfinder.



- A higher f/number will make more of the foreground and background fall within acceptable focus. However, the viewfinder will look darker.
- The depth-of-field effect can be clearly seen on the Live View image as you change the aperture and press the depth-of-field preview button (p.152).
- The exposure will be locked (AE lock) while the depth-of-field preview button is pressed.

M: Manual Exposure

In this mode, you set both the shutter speed and aperture as desired. To determine the exposure, refer to the exposure level indicator in the viewfinder or use a commercially-available exposure meter. This method is called manual exposure.

* <M> stands for Manual.



1 Set the Mode Dial to <M>.



2 Set the shutter speed and aperture.

- To set the shutter speed, turn the <☀> dial.
- To set the aperture, turn the <⊙> dial. If the aperture cannot be set, press the <UNLOCK> button below the <⊙> dial (⌚4), then turn the <⊙> dial.

Standard exposure index



Exposure level mark

3 Focus the subject.

- Press the shutter button halfway.
- ▶ The exposure setting will be displayed in the viewfinder and on the LCD panel.
- The exposure level mark <↑> indicates how far the current exposure level is from the standard exposure level.

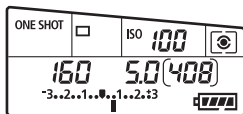

4 Set the exposure.

- Check the exposure level and set the desired shutter speed and aperture.

5 Take the picture.

ⓘ If the [☑ Auto Lighting Optimizer] (p.101) is set to anything other than [Disable], the image may still look bright even if a darker exposure has been set.

Selecting the Metering Mode ☆

You can select one of four methods to measure the subject brightness. In Basic Zone modes, evaluative metering is set automatically.



1 Press the  button. (ⓘ6)



2 Select the metering mode.

- While looking at the LCD panel, turn the  dial.

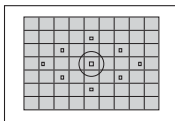

Evaluative metering

This is a general-purpose metering mode suited for portraits and even backlit subjects. The camera sets the exposure automatically to suit the scene.

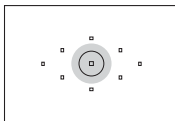

Partial metering

Effective when the background is much brighter than the subject due to backlighting, etc. Partial metering covers approx. 6.5% of the viewfinder area at the center.

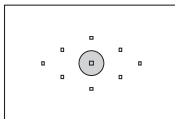

Spot metering

This is for metering a specific spot of the subject or scene. The metering is weighted at the center covering approx. 2.8% of the viewfinder area.

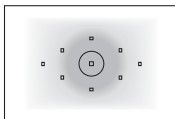

Center-weighted average metering

The metering is weighted at the center and then averaged for the entire scene.

Setting Exposure Compensation ☆

Exposure compensation can brighten (increased exposure) or darken (decreased exposure) the standard exposure set by the camera. Although you can set the exposure compensation up to ± 5 stops in 1/3-stop increments, the exposure compensation indicator on the LCD panel and in the viewfinder can only display the setting up to ± 3 stops. If you want to set the exposure compensation setting beyond ± 3 stops, you should use the Quick Control screen (p.44) or follow the instructions for [☑: Exp. comp./AEB] on the next page.



1 Set the Mode Dial to <P>, <Tv>, or <Av>.

Increased exposure for a brighter image



Decreased exposure for a darker image



2 Set the exposure compensation amount.

- After pressing the shutter button halfway (ⓘ4), turn the <⊙> dial. If the exposure compensation cannot be set, press the <UNLOCK> button below the <⊙> dial (ⓘ4), then turn the <⊙> dial.

3 Take the picture.

- To cancel the exposure compensation, set the exposure compensation amount back to <⊙>.

ⓘ If the [☑: Auto Lighting Optimizer] (p.101) is set to anything other than [Disable], the image may still look bright even if a darker exposure has been set.

- The exposure compensation amount will remain in effect even after you set the power switch to <OFF>.
- Be careful not to turn the <⊙> dial and change the exposure compensation inadvertently. It is safest to set the [☑: Lock ⊙] menu to [Enable]. Before turning the <⊙> dial, press the <UNLOCK> button (ⓘ4), then turn the <⊙> dial.
- If the amount set exceeds ± 3 stops, the end of the exposure level indicator will display <◀> or <▶>.

Auto Exposure Bracketing (AEB) ☆

By changing the shutter speed or aperture automatically, the camera brackets the exposure up to ± 3 stops in 1/3-stop increments for three successive shots. This is called AEB.

* AEB stands for Auto Exposure Bracketing.



1 Select [Expo. comp./AEB].

- Under the [Fn] tab, select [Expo. comp./AEB], then press <SET>.

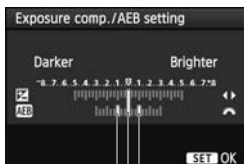

AEB amount

2 Set the AEB amount.

- Turn the <DISP> dial to set the AEB amount.
- Press the <◀▶> key to set the exposure compensation amount. If AEB is combined with exposure compensation, AEB will be applied centering on the exposure compensation amount.
- Press <SET> to set it.
- ▶ When you exit the menu, <Fn> and the AEB level will be displayed on the LCD panel.

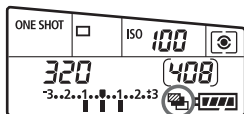

3 Take the picture.

- Focus and press the shutter button completely. The three bracketed shots will be taken in this sequence: Standard exposure, decreased exposure, and increased exposure.

Canceling AEB

- Follow steps 1 and 2 to turn off the AEB amount display.
- AEB will be canceled automatically when you set the power switch to <OFF> or when the flash is ready to fire.



- If the drive mode is set to <□>, you must press the shutter button three times. When <□H> or <□> is set and you hold down the shutter button completely, the three bracketed shots will be taken continuously. Then the camera will stop shooting. When <□2> or <□2> is set, the three bracketed shots will be taken continuously after a 10-sec. or 2-sec. delay.
- Neither flash nor bulb exposures can be used with AEB.

* AE Lock ☆

Use AE lock when the area of focus is to be different from the exposure metering area or when you want to take multiple shots at the same exposure setting. Press the < * > button to lock the exposure, then recompose and take the shot. This is called AE lock. It is effective for backlit subjects.



1 Focus the subject.

- Press the shutter button halfway.
▶ The exposure setting will be displayed.



2 Press the < * > button. (☆)

- ▶ The < * > icon lights in the viewfinder to indicate that the exposure setting is locked (AE lock).
 - Each time you press the < * > button, it locks the current auto exposure setting.

3 Recompose and take the picture.

- If you want to maintain the AE lock while taking more shots, hold down the < * > button and press the shutter button to take another shot.

AE Lock Effects

Metering Mode (p.119)	AF Point Selection Method (p.78)	
	Automatic Selection	Manual Selection
	AE lock is applied at the AF point that achieved focus.	AE lock is applied at the selected AF point.
	AE lock is applied at the center AF point.	

* When the lens' focus mode switch is set to <MF>, AE lock is applied at the center AF point.

B: Bulb Exposures

When bulb is set, the shutter stays open as long as you hold down the shutter button completely, and closes when you let go of the shutter button. This is called bulb exposure. Use bulb exposures for night scenes, fireworks, the heavens, and other subjects requiring long exposures.



1 Set the Mode Dial to ****.

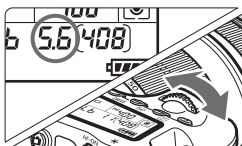

2 Set the desired aperture.

- While looking at the LCD panel, turn the or dial.

3 Take the picture.

- While you hold down the shutter button, the exposure will continue.
- ▶ The elapsed exposure time will be displayed on the LCD panel.

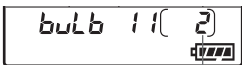

Elapsed exposure time



- Since bulb exposures produce more noise than usual, the image might look a little grainy.
- When [**C.Fn II -1: Long exp. noise reduction**] is set to [**1: Auto**] or [**2: On**], noise generated by the bulb exposure can be reduced (p.254).



- For bulb exposures, using a tripod and Remote Switch (p.124) is recommended.
- You can also use a remote controller (sold separately, p.126) for bulb exposures. When you press the remote controller's transmit button, the bulb exposure will start immediately or 2 sec. later. Press the button again to stop the bulb exposure.

Using the Eyepiece Cover

If you take a picture without looking at the viewfinder, light entering the eyepiece can throw off the exposure. To prevent this, use the eyepiece cover (p.23) attached to the camera strap.

During Live View shooting and movie shooting, attaching the eyepiece cover is unnecessary.

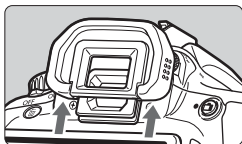

1 Remove the eyecup.

- Push the bottom of the eyecup to remove.

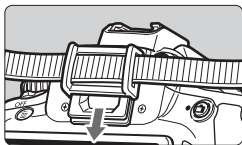

2 Attach the eyepiece cover.

- Slide the eyepiece cover down into the eyepiece groove to attach it.

Using the Remote Switch

Remote Switch RS-60E3 (sold separately) comes with an approx. 60cm/2.0ft cord. When connected to the camera's remote control terminal, Remote Switch RS-60E3 can be used to press the shutter button halfway and completely.

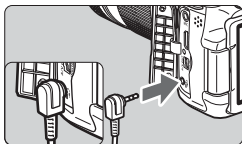

Mirror Lockup ☆

Although using the self-timer or Remote Switch can prevent camera shake, using mirror lockup to prevent camera vibrations (mirror shock) can also help when you use a super telephoto lens or shoot close ups (macro photography).

When [C.Fn III -5: Mirror lockup] is set to [1: Enable], shooting with mirror lockup will be possible (p.257).

1 Focus the subject, then press the shutter button completely.

- ▶ The mirror will swing up.

2 Press the shutter button completely again.

- ▶ The picture is taken and the mirror goes back down.



- In very bright light such as at the beach or a ski slope on a sunny day, take the picture promptly after mirror lockup.
- Do not point the camera toward the sun. The sun's heat can scorch and damage the shutter curtains.
- If you use the self-timer and mirror lockup in combination with a bulb exposure, keep pressing the shutter button completely (self-timer delay time + bulb exposure time). If you let go of the shutter button during the self-timer countdown, there will be a shutter-release sound, but no picture will be taken.



- When [1: Enable] is set, single shooting will take effect even if the drive mode is set to continuous.
- When the self-timer is set to <10> or <2>, the picture will be taken after 10 sec. or 2 sec. respectively.
- If 30 seconds elapse after the mirror has locked up, it will go back down automatically. Pressing the shutter button completely again locks up the mirror again.
- For mirror lockup, using Remote Switch RS-60E3 (sold separately) is recommended (p.124).
- You can also lockup the mirror and shoot with a remote controller (sold separately, p.126). Setting the remote controller to a 2-sec. delay is recommended.

Remote Control Shooting



With Remote Controller RC-6 (sold separately), you can shoot remotely up to approx. 5 meters/16.4 feet from the camera. You can either shoot immediately or use a 2-sec. delay.

You can also use Remote Controller RC-1 and RC-5.

1 Focus the subject.

2 Set the lens focus mode switch to <MF>.

- You can also shoot with <AF>.

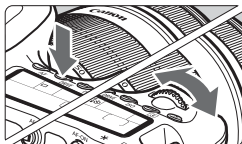

3 Press the <DRIVE> button. (ⓘ6)

4 Select the self-timer.

- Look at the LCD panel and turn the <ⓘ6> dial to select <ⓘ6> or <ⓘ6_2>.

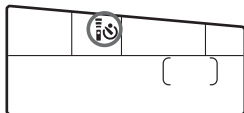

5 Press the remote controller's transmit button.

- Point the remote controller toward the camera's remote control sensor and press the transmit button.
- ▶ The self-timer lamp lights and the picture is taken.

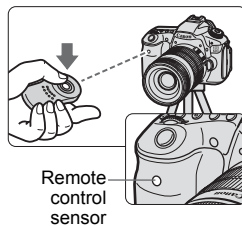

ⓘ Camera misoperation may occur near certain types of fluorescent lights. During wireless remote control, try to keep the camera away from fluorescent light sources.

Displaying the Electronic Level

To help level the camera, the electronic level can be displayed on the LCD monitor, in the viewfinder, and on the LCD panel. Note that only the horizontal level will be displayed. (No vertical level.)

Displaying the Electronic Level on the LCD Monitor

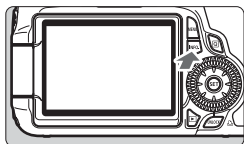

1 Press the <INFO,> button.

- Each time you press the <INFO.> button, the screen display will change.
- Display the electronic level.
- If the electronic level does not appear, set the menu's [: **INFO. button display options**] option to display the electronic level (p.266).



2 Check the camera's tilt.

- The horizontal tilt is displayed in 1° increments.
- When the red line turns green, it indicates that the tilt is corrected.



Horizontal level

- Even when the tilt is corrected, there is a margin of error of $\pm 1^\circ$.
- If the camera is significantly tilted, the electronic level's margin of error will be greater.

 The electronic level can also be displayed during Live View shooting and movie shooting (p.154, 176).

Displaying the Electronic Level in the Viewfinder

The electronic level display in the viewfinder and on the LCD panel uses the exposure level scale. Note that the electronic level is only displayed when shooting in horizontal orientation. It is not displayed in vertical orientation.



1 Select Custom Functions IV.

- Select the [C.Fn IV: Operation/Others] menu, then press <SET>.



2 Select C.Fn IV -2 [Assign SET button].

- Press the <◀▶> key to select [2] [Assign SET button], then press <SET>.

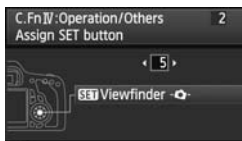

3 Select [5]: [SET Viewfinder -📷-].

- Press the <◀▶> key to select [5]: [SET Viewfinder -📷-], then press <SET>.
- Press the <MENU> button two times to exit the menu.



4° right tilt



4° left tilt



4 Display the electronic level.

- Press <SET>.
- ▶ In the viewfinder and on the LCD panel, the electronic level will use the exposure scale to display the horizontal tilt up to $\pm 9^\circ$ in 1° increments.
- Pressing the shutter button halfway will switch the exposure level scale back to indicating the exposure level.

- ⚠ Even when the tilt is corrected, there still may be a margin of error of $\pm 1^\circ$.
- If you point the camera up or down, the electronic level will not be correctly displayed.

6

Flash Photography

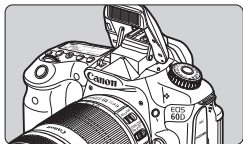

With the built-in flash, you can shoot with autofocus, manual flash, and wireless flash.



In Creative Zone modes, just press the **<⚡>** button to pop-up the built-in flash. To retract the built-in flash, push it back down with your fingers.



In Basic Zone modes (except **<📷>** **<📷>** **<📷>**), the built-in flash will pop-up and fire automatically in low-light and backlit conditions. The **<CA>** mode enables you to select between automatic flash firing and flash on/off (p.61).

Flash cannot be used with movie shooting.

⚡ Using the Built-in Flash

In Basic Zone modes and Creative Zone modes, the shutter speed and aperture for flash photography will be set as shown below. By default, E-TTL II autoflash control (flash autoexposure) will be used in all shooting modes.

Shooting Mode	Shutter Speed	Aperture
	Automatically set within 1/250 sec. - 1/60 sec.	Automatically set
	Automatically set within 1/250 sec. - 2 sec.	Automatically set
P	Automatically set within 1/250 sec. - 1/60 sec.	Automatically set
Tv	Set manually within 1/250 sec. - 30 sec.	Automatically set
Av	Automatically set	Set manually
M	Set manually within 1/250 sec. - 30 sec.	Set manually
B	While you hold down the shutter button, the exposure will continue.	Set manually

 With [ **C.Fn I -7: Flash sync. speed in Av mode**] (p.253), the following options for flash automatic setting can be selected: Applicable in the **<Av>** shooting mode.

- 0: Auto*
- 1: 1/250 - 1/60 sec. auto
- 2: 1/250 sec. (fixed)

* Normally, the sync speed is set automatically within 1/250 sec. to 30 sec. to suit the ambient brightness. In low light, the main subject is exposed with the automatic flash, and the background is exposed with a slow shutter speed set automatically. The standard exposure will be obtained for both the subject and the background (automatic slow flash sync speed). With slow shutter speeds, using a tripod is recommended.

Effective Range of Built-in Flash

[Approx. meters/feet]

Aperture	ISO Speed							
	100	200	400	800	1600	3200	6400	H: 12800
f/3.5	3.5 / 12	5.5 / 17	7.5 / 24	11 / 34	15 / 49	21 / 69	30 / 97	42 / 138
f/4	3 / 11	4.5 / 15	6.5 / 21	9 / 30	13 / 43	18 / 60	26 / 85	36 / 121
f/5.6	2.5 / 7.5	3.5 / 11	4.5 / 15	6.5 / 22	9.5 / 30	13 / 43	19 / 61	26 / 86



- For close subjects, the subject should be at least 1 meter/3.3 feet away when using flash.
- Detach the lens hood and keep at least 1 meter/3.3 feet away from the subject.
- If the lens has a hood attached or if you are too close to the subject, the bottom of the picture might look dark due to the obstructed flash. If you use a telephoto lens or a fast lens and the built-in flash is still partially obstructed, use an EX-series Speedlite (sold separately).

MENU Using Red-eye Reduction

Using the red-eye reduction lamp before taking a flash picture can reduce red eye. Red-eye reduction will work in any shooting mode except > > > > .

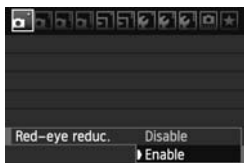

- Under the [] tab, select [**Red-eye reduc.**], then press <SET>. Select [**Enable**], then press <SET>.
- For flash photography, when you press the shutter button halfway, the red-eye reduction lamp will light. Then when you press the shutter button completely, the picture will be taken.



- The red-eye reduction feature is most effective when the subject looks at the red-eye reduction lamp, when the room is well lit, or when you are close to the subject.
- When you press the shutter button halfway, the display on the viewfinder bottom will gradually turn off. For best results, take the picture after this display turns off.
- The effectiveness of red-eye reduction varies depending on the subject.



⚡ Flash Exposure Compensation ☆

Set flash exposure compensation if the flash exposure of the subject does not come out as desired. You can set flash exposure compensation up to ± 3 stops in $1/3$ -stop increments.

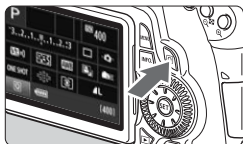

1 Display the Quick Control screen.

- Press the $\langle \text{Q} \rangle$ button (p.44).
- ▶ The Quick Control screen will appear ($\odot 10$).



2 Select [⚡*].

- Press the $\langle \blacktriangle \nabla \rangle$ and $\langle \blacktriangle \blacktriangleright \rangle$ key to select [⚡*], then press $\langle \text{SET} \rangle$.
- ▶ The flash exposure compensation screen will appear.



3 Set the flash exposure compensation amount.

- To make the flash exposure brighter, turn the $\langle \odot \rangle$ dial to the right. (Increased exposure)
Or to make it darker, turn the $\langle \odot \rangle$ dial to the left. (Decreased exposure)
- ▶ When you press the shutter button halfway, the $\langle \text{⚡} \rangle$ icon will be displayed in the viewfinder and on the LCD panel.
- After taking the picture, do steps 1 to 3 to return the flash exposure compensation amount to zero.



- If the [ **Auto Lighting Optimizer**] (p.101) is not set to [**Disable**], the image may still look bright even if a darker flash exposure has been set.
- If you set flash exposure compensation with both the camera and EX-series Speedlite, the Speedlite's flash exposure compensation setting will override the camera's. If you have set flash exposure compensation with an EX-series Speedlite, any flash exposure compensation set with the camera will not take effect.



- The exposure compensation amount will remain in effect even after you set the power switch to <OFF>.
- By setting [ **C.Fn IV -2: Assign SET button**] to [4: **SET Flash exp. comp.**], you can just press <SET> to display the flash exposure compensation setting screen.
- The camera can also be used to set the EX-series Speedlite's flash exposure compensation in the same way as with the Speedlite.

✳ FE Lock ☆

FE (flash exposure) lock obtains and locks the standard flash exposure reading for any part of a subject.

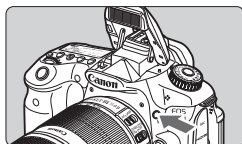

1 Press the <⚡> button to pop-up the built-in flash.

- Press the shutter button halfway and look in the viewfinder to check that the <⚡> icon is lit.

2 Focus the subject.

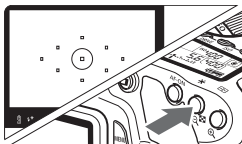

3 Press the <✳> button. (☺16)

- Aim the viewfinder center over the subject where you want to lock the flash exposure, then press the <✳> button.
 - ▶ The flash will fire a preflash and the required flash output is calculated and retained in memory.
 - ▶ In the viewfinder, “FEL” is displayed for a moment and <⚡✳> will light.
- Each time you press the <✳> button, a preflash is fired and the required flash output is calculated and retained in memory.

4 Take the picture.

- Compose the shot and press the shutter button completely.
 - ▶ The flash is fired when the picture is taken.



⚠ If the subject is too far away and beyond the effective range of the flash, the <⚡> icon will blink. Get closer to the subject and repeat steps 2 to 4.

MENU Setting the Flash ☆

The built-in flash and external Speedlite settings can be set with the camera's menu. You can use those menu options for the external Speedlite only if the attached **EX-series Speedlite are compatible with them**.

The setting procedure is the same as setting a camera menu function.

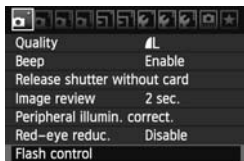

Select [Flash control].

- Under the [] tab, select [Flash control], then press < (SET) >.
- ▶ The flash control screen will appear.

[Flash firing]

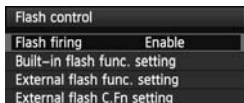

- Normally, set this to [Enable].
- If [Disable] is set, both the built-in flash and external Speedlite will not fire. This is useful when you only want to use the flash's AF-assist beam.

[Built-in flash func. setting] and [External flash func. setting]

The [Built-in flash func. setting] and [External flash func. setting] menus can set the functions listed on the next page. The functions displayed under [External flash func. setting] will vary depending on the Speedlite model.

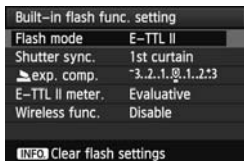

- Select [Built-in flash func. setting] or [External flash func. setting].
- ▶ The flash functions will be displayed. The functions not dimmed can be selected and set.

[Built-in flash func. setting] and [External flash func. setting] Settable Functions

Function	[Built-in flash func. setting]	[External flash func. setting]	Page
Flash mode	○		136
Shutter sync.	○		137
FEB*	—	○	—
Flash exposure compensation	○		132
E-TTL II flash metering	○		137
Zoom*	—	○	—
Wireless flash	○		139

* For [FEB] (Flash exposure bracketing) and [Zoom], refer to the Speedlite's instruction manual.

● Flash mode

You can select the flash mode to suit your desired flash shooting.

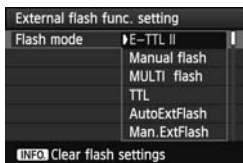
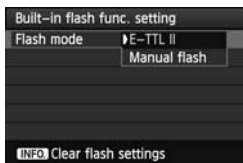

- [E-TTL II] is the standard mode of EX-series Speedlites for automatic flash shooting.
- [Manual flash] is for advanced users who want to set the [Flash output] (1/1 to 1/128) themselves.
- Regarding other flash modes, refer to your Speedlite's instruction manual.

- **Shutter sync.**

Normally, set this to **[1st curtain]** so that the flash fires immediately after the exposure starts.

If **[2nd curtain]** is set, the flash will fire right before the exposure ends. When this is combined with a slow sync speed, you can create a trail of light such as from car headlights at night. With 2nd curtain sync, two flashes will be fired, once when you press the shutter button completely, and once immediately before the exposure ends. However, with shutter speeds faster than 1/30 sec., 1st curtain sync will automatically take effect.

If an external Speedlite is attached, you can also set **[Hi-speed]** (⚡_H). For details, see the Speedlite's instruction manual.

- **Flash exposure compensation**

See “ Flash Exposure Compensation” on page 132.

- **E-TTL II flash metering**

For normal flash exposures, set it to **[Evaluative]**.

If **[Average]** is set, the flash exposure will be averaged for the entire metered scene as with an external metering flash. Since flash exposure compensation may be necessary depending on the scene, this setting is for advanced users.

- **Wireless flash**

See “Using Wireless Flash” on page 139.

- **Clear flash settings**

With the **[Built-in flash func. setting]** or **[External flash func. setting]** screen displayed, press the **<INFO.>** button to display the screen to clear the flash settings. When you select **[OK]**, the settings for the flash will be cleared.

Setting the External Speedlite Custom Functions

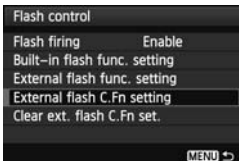

1 Display the Custom Function.

- With the camera ready to shoot with an external Speedlite, select **[External flash C.Fn setting]**, then press <SET>.

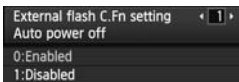

2 Set the Custom Function.

- Press the <◀▶> key to select the function number, then set the function. The procedure is the same as setting the camera's Custom Functions (p.250).
- To clear all the Custom Function settings, select **[Clear ext. flash C.Fn set.]** in step 1.

Using Wireless Flash ☆

The camera's built-in flash can work as a master unit with Canon Speedlites having a wireless slave feature and wirelessly trigger the Speedlite to fire. Be sure to read about wireless flash photography in the Speedlite's instruction manual.

Slave Unit Settings and Position

Regarding your Speedlite (slave unit), refer to its instruction manual and set it as follows. Slave unit control settings other than the below are all set with the camera. Different types of slave units can be used and controlled together.

- (1) Set the Speedlite as a slave unit.
- (2) Set the Speedlite's transmission channel to the same one as the camera's.
- (3) If you want to set the flash ratio (p.144), set the slave unit ID.
- (4) Position the camera and slave unit(s) within the range shown below.
- (5) Face the slave unit's wireless sensor toward the camera.

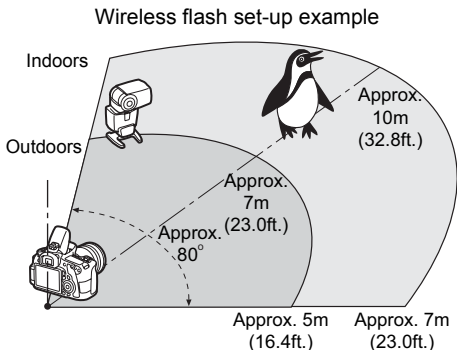

Canceling the slave unit's auto power off



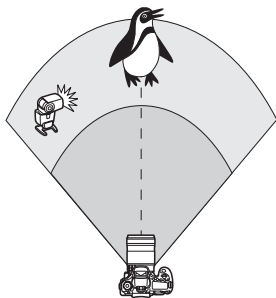

To cancel the slave unit's auto power off, press the camera's <✳> button. If you are using manual flash firing, press the slave unit's test firing (PILOT) button to cancel the auto power off.

Fully Automatic Shooting with One External Speedlite



This shows the most basic setup for fully-automatic wireless flash with one Speedlite.

Steps 1 to 3 and 6 to 7 apply to all wireless flash shooting. Therefore, these steps are omitted in the other wireless flash setups explained on the pages hereafter.

On the menu screens, the  and  icons refer to the external Speedlite, and the  and  icons refer to the built-in flash.

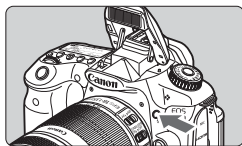

1 Press the button to pop-up the built-in flash.

- For wireless flash, be sure to pop-up the built-in flash.

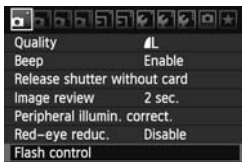

2 Select [Flash control].

- Under the [] tab, select [Flash control], then press .



3 Select [Built-in flash func. setting].

- Select [Built-in flash func. setting], then press .

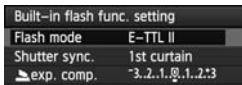

4 Select [Flash mode].

- For [Flash mode], select [E-TTL II], then press .

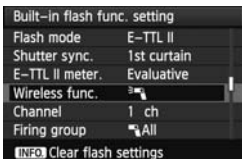

5 Select [Wireless func.].

- For [Wireless func.], select [, then press <SET>.
- ▶ Under [Wireless func.], [Channel], etc., will be displayed.

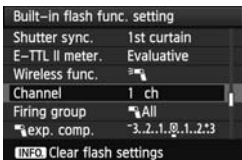

6 Set [Channel].

- Set the channel (1-4) to the same one as the slave unit.

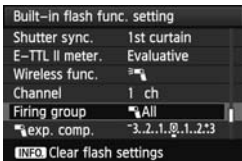

7 Select [Firing group].

- For [Firing group], select [ All], then press <SET>.

8 Take the picture.

- As with normal flash shooting, you can set the camera and take the picture in the same way.
- To terminate wireless flash shooting, set [Wireless func.] to [Disable].



- Setting [E-TTL II meter.] to [Evaluative] is recommended.
- Even if you disable the built-in flash from firing, it will still fire to control the slave unit. Depending on shooting conditions, the flash firing for slave unit control may be visible in the picture.
- The slave unit cannot fire a test flash.

Fully-automatic Shooting with One External Speedlite and Built-in Flash

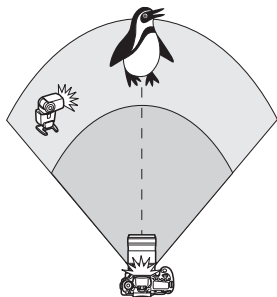

This shows fully-automatic wireless flash shooting with one external Speedlite and the built-in flash.

You can change the flash ratio between the external Speedlite and built-in flash to adjust how the shadows look on the subject.

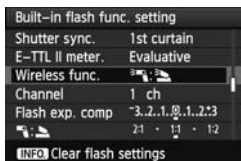

1 Select [Wireless func.].

- Follow step 5 on page 141 to select [:] for [Wireless func.], then press < >.

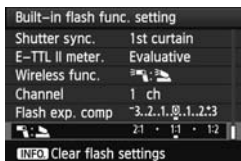

2 Set the desired flash ratio and shoot.

- Select [:] and set the flash ratio within 8:1 to 1:1. Setting a flash ratio to the right of 1:1 (up to 1:8) is not possible.
- If the built-in flash output is not enough, set a higher ISO speed (p.88).

The 8:1 to 1:1 flash ratio is equivalent to 3:1 to 1:1 stops (1/2-stop increments).

Fully-automatic Shooting with Multiple External Speedlites

Multiple Speedlite slave units can be treated as one flash unit or separated into slave groups whose flash ratio can be set.

The basic settings are shown below. By changing the **[Firing group]** setting, you can shoot with various wireless flash setups with multiple Speedlites.

Built-in flash func. setting	
Flash mode	E-TTL II
Shutter sync.	1st curtain
E-TTL II meter.	Evaluative
Wireless func.	☞
Channel	1 ch
Firing group	All
INFO Clear flash settings	

Basic settings:

Flash mode : E-TTL II

E-TTL II meter. : Evaluative

Wireless func. : ☞

Channel : (Same as slave units)

[☞All] Using multiple slave Speedlites as one flash unit

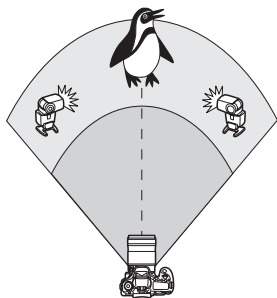

Convenient when you need a large flash output. All the slave Speedlites will fire at the same output and controlled to obtain a standard exposure.

No matter what the slave ID is (A, B, or C), all the slave units will fire as one group.

Built-in flash func. setting	
Shutter sync.	1st curtain
E-TTL II meter.	Evaluative
Wireless func.	☞
Channel	1 ch
Firing group	All
exp. comp.	-3.2..1..0..1..2..3
INFO Clear flash settings	

Set **[Firing group]** to **[☞All]**, then shoot.

[(A:B)] Multiple slave units in multiple groups

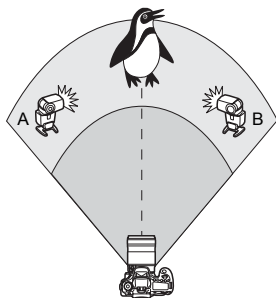

Divide the slave units into groups A and B, and change the flash ratio to obtain the desired lighting effect.

Refer to your Speedlite's instruction manual to set one slave unit's slave ID to A (Group A) and the other slave unit's ID to B (Group B) and position them as shown in the illustration.

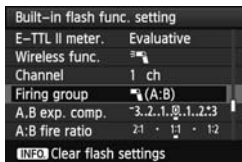

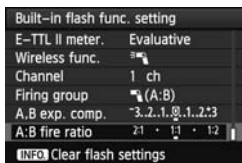

1 Set [Firing group] to [(A:B)].



2 Set the desired flash ratio and shoot.

- Select [A:B fire ratio] and set the flash ratio.

 If [Firing group] is set to [ (A:B)], group C will not fire.

 The 8:1 to 1:1 to 1:8 flash ratio is equivalent to 3:1 to 1:1 to 1:3 stops (1/2-stop increments).

Fully-automatic Shooting with the Built-in Flash and Multiple External Speedlites

The built-in flash can also be added to wireless flash shooting explained on pages 143-144.

The basic settings are shown below. By changing the **[Firing group]** setting, you can shoot with various wireless flash setups of multiple Speedlites complemented with the built-in flash.

Built-in flash func. setting	
Flash mode	E-TTL II
Shutter sync.	1st curtain
E-TTL II meter.	Evaluative
Wireless func.	[Flash icon] + [Wireless icon]
Channel	1 ch
exp. comp.	-3.2..1..0..1..2:3
[INFO] Clear flash settings	

1 Basic settings:

Flash mode : E-TTL II
E-TTL II meter. : Evaluative
Wireless func. : [Flash icon] + [Wireless icon]
Channel : (Same as slave units)

Built-in flash func. setting	
E-TTL II meter.	Evaluative
Wireless func.	[Flash icon] + [Wireless icon]
Channel	1 ch
exp. comp.	-3.2..1..0..1..2:3
Firing group	[Flash icon] All and [Wireless icon]
exp. comp.	-3.2..1..0..1..2:3
[INFO] Clear flash settings	

2 Select [Firing group].

- Select the firing group, then set the flash ratio, flash exposure compensation, and other necessary settings before shooting.

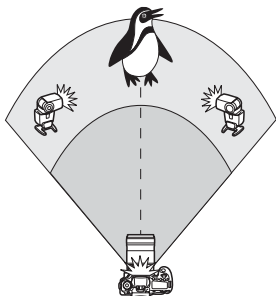

[Flash icon] All and [Wireless icon]

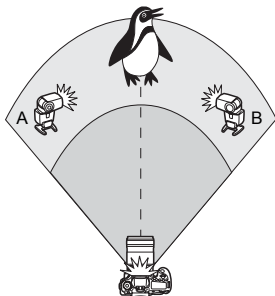

[Flash icon] (A:B) [Wireless icon]

Creative Wireless Flash Shooting

Flash exposure compensation

When [**Flash mode**] is set to [**E-TTL II**], flash exposure compensation can be set. The flash exposure compensation settings (see below) which can be set will differ depending on the [**Wireless func.**] and [**Firing group**] settings.

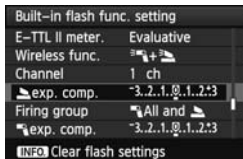

[Flash exp. comp]

- The flash exposure compensation is applied to the built-in flash and all external Speedlites.

[Flash icon] exp. comp.]

- The flash exposure compensation is applied to the built-in flash.

[Flash icon with A] exp. comp.]

- The flash exposure compensation is applied to all external Speedlites.

[A,B exp. comp.]

- The flash exposure compensation is applied to both groups A and B.

FE lock

If [**Flash mode**] is set to [**E-TTL II**], you can press the <★> button to set FE lock.

Setting the Flash Output Manually for Wireless Flash

When **[Flash mode]** is set to **[Manual flash]**, the flash output can be set manually. The flash output settings (**[Flash output]**, **[Group A output]**, etc.) that can be set will differ depending on the **[Wireless func.]** setting (see below).

Built-in flash func. setting	
Flash mode	Manual flash
Shutter sync.	1st curtain
Wireless func.	
Channel	1 ch
Firing group	All
flash output	1/4 . . 1/2 . . 1/1
INFO Clear flash settings	

[Wireless func.:]

- **[Firing group: All]**: The manual flash output setting will be applied to all the external Speedlites.
- **[Firing group: (A:B)]**: You can set the flash output separately for slave groups A and B.

[Wireless func.: +]

- **[Firing group: All and]**: The flash output can be set separately for the external Speedlite(s) and built-in flash.
- **[Firing group: (A:B)]**: You can set the flash output separately for slave groups A and B. You can also set the flash output for the built-in flash.

External Speedlites

EOS-dedicated, EX-series Speedlites

Basically operates like a built-in flash for easy operation.

When an EX-series Speedlite (sold separately) is attached to the camera, almost all the autoflash control is done by the camera. In other words, it is like a high-output flash attached externally in place of the built-in flash.

For detailed instructions, **see the EX-series Speedlite's instruction manual.** This camera is a Type-A camera that can use all the features of EX-series Speedlites.



Shoe-mount Speedlites



Macro Lites

- With an EX-series Speedlite not compatible with flash function settings (p.135), only [**exp. comp**] and [**E-TTL II meter.**] can be set for [**External flash func. setting**]. (Certain EX-series Speedlites also enable [**Shutter sync.**] to be set.)
- If the flash metering mode is set to TTL autoflash with the Speedlite's Custom Function, the flash will fire at full output only.

Canon Speedlites other than the EX-series

- **With an EZ/E/EG/ML/TL-series Speedlite set in TTL or A-TTL autoflash mode, the flash can be fired at full output only.** Set the camera's shooting mode to <M> (manual exposure) or <Av> (aperture-priority AE) and adjust the aperture setting before shooting.
- When using a Speedlite which has manual flash mode, shoot in the manual flash mode.

Using Non-Canon Flash Units

Sync Speed

The camera can synchronize with non-Canon compact flash units at 1/250 sec. and slower speeds. With large studio flash units, since the flash duration is longer than compact flash units, set the sync speed within 1/60 sec. to 1/30 sec. Be sure to test the flash synchronization before shooting.

Cautions for Live View shooting

If you use a non-Canon flash with Live View shooting, set [ **Silent shooting**] to [**Disable**] (p.159). The flash will not fire if it is set to [**Mode 1**] or [**Mode 2**].



- If the camera is used with a flash unit or flash accessory dedicated to another camera brand, the camera may not operate properly and malfunction may result.
- The camera does not have a PC terminal.
- Do not attach a high-voltage flash unit on the camera's hot shoe. It might not fire.



7

Shooting with the LCD Monitor (Live View Shooting)

You can shoot while viewing the image on the camera's LCD monitor. This is called "Live View shooting".

Live View shooting is effective for still subjects which do not move.

If you handhold the camera and shoot while viewing the LCD monitor, camera shake can cause blurred images. Using a tripod is recommended.



About Remote Live View Shooting

With EOS Utility (provided software) installed in your computer, you can connect the camera to the computer and shoot remotely while viewing the computer screen. For details, see the Software Instruction Manual in the CD-ROM.

Shooting with the LCD Monitor



1 Display the Live View image.

- Press the  button.
- ▶ The image will appear on the LCD monitor.
- The image's field of view is approx. 100%.



2 Focus the subject.



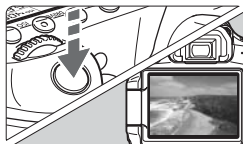

- When you press the shutter button halfway, the camera will focus with the current AF mode (p.160-167).



3 Take the picture.

- Press the shutter button completely.
- ▶ The picture will be taken and the captured image is displayed on the LCD monitor.
- ▶ After the image review ends, the camera will return to Live View shooting automatically.
- Press the  button to exit Live View shooting.

About the White and Red Internal Temperature Warning Icons

- If the camera's internal temperature increases due to prolonged Live View shooting or a high ambient temperature, a white  icon will appear. If you continue shooting while this icon is displayed, the image quality of still photos may deteriorate. You should stop the Live View shooting and allow the camera to cool down before shooting again.
- If the camera's internal temperature further increases while the white  icon is displayed, a red  icon will start blinking. This blinking icon is a warning that the Live View shooting will soon be terminated automatically. If this happens, you will not be able to shoot again until the camera's internal temperature decreases. Turn off the power and let the camera rest for a while.
- Live View shooting at high temperature for a prolonged period will cause the  and  icons to appear sooner. When not shooting, turn off the camera.

Enabling Live View Shooting

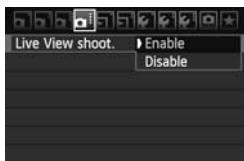

Set the [**Live View shoot.**] menu to [**Enable**].

Battery Life with Live View Shooting [Approx. number of shots]

Temperature	Shooting Conditions	
	No Flash	50% Flash Use
At 23°C / 73°F	350	320
At 0°C / 32°F	310	280

- The figures above are based on a fully-charged Battery Pack LP-E6 and CIPA (Camera & Imaging Products Association) testing standards.
- With a fully-charged Battery Pack LP-E6, the total time of Live View shooting is possible as follows: Approx. 2 hr. 20 min. at 23°C / 73°F.



- During Live View shooting, do not point the lens toward the sun. The sun's heat can damage the camera's internal components.
- **Cautions for using Live View shooting are on pages 168-169.**



- You can also focus by pressing the <AF-ON> button.
- When flash is used, there will be two shutter sounds, but only one shot will be taken.
- With the Live View image displayed, you can playback <▶> images.
- If the camera is not operated for a prolonged period, the power will turn off automatically as set with [**Auto power off**] (p.50). If [**Auto power off**] is set to [**Off**], the Live View function will stop automatically after 30 min. (camera power remains on).
- With the AV cable (provided) or HDMI cable (sold separately), you can display the Live View image on a TV (p.209, 212).

About the Information Display

- Each time you press the <INFO.> button, the information display will change.

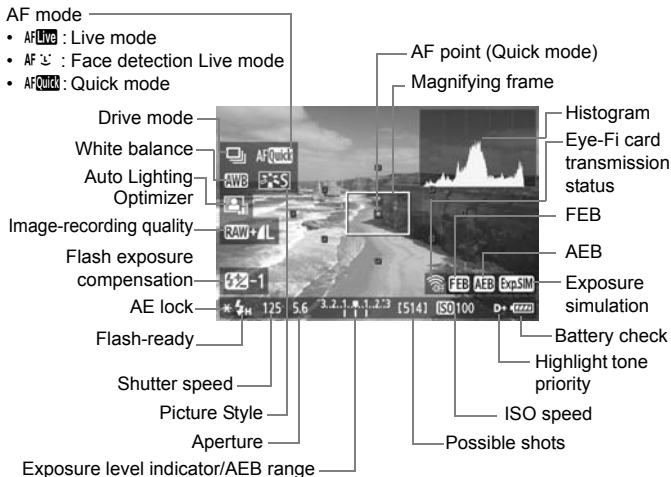

- The histogram can be displayed when [**Expo. simulation: Enable**] has been set (p.158).
- You can display the electronic level by pressing the <INFO.> button (p.266). Note that if the AF mode is set to [**Live mode**] or the camera is connected to a TV set with an HDMI cable, the electronic level cannot be displayed.
- When <Exp.SIM> is displayed in white, it indicates that the Live View image brightness is close to what the captured image will look like.
- If <Exp.SIM> is blinking, it indicates that the Live View image is not being displayed at the suitable brightness due to low or bright light conditions. However, the actual image recorded will reflect the exposure setting.
- If flash is used or bulb is set, the <Exp.SIM> icon and histogram will be grayed out (for your reference). The histogram might not be properly displayed in low- or bright-light conditions.

Final Image Simulation

The final image simulation reflects the effects of the Picture Style, white balance, etc., in the Live View image so you can see what the captured image will look like. During still photo shooting, the Live View image will automatically reflect the settings listed below.

Final image simulation for still images

- Picture Style
 - * All settings such as sharpness, contrast, color saturation, and color tone will be reflected.
- White balance
- White balance correction
- Shoot by ambience selection
- Shoot by lighting or scene type
- Exposure (With Exposure Simulation set to **[Enable]**)
- Depth of field (With depth-of-field preview button ON)
- Auto Lighting Optimizer
- Peripheral illumination correction
- Highlight tone priority
- Aspect ratio (Image area confirmation)

Menu Function Settings



Live View shoot.	Enable
AF mode	Live mode
Grid display	Off
Aspect ratio	3:2
Expo. simulation	Enable
Silent shooting	Mode 1
Metering timer	16 sec.

Function settings particular to Live View shooting are explained here. The menu options under the [] tab are explained below.

The functions settable on this menu screen only apply during Live View shooting. These functions do not take effect during viewfinder shooting.

● Live View shooting

Set Live View shooting to [Enable] or [Disable].

● AF mode

You can select [Live mode] (p.160), [Live mode] (p.161), or [Quick mode] (p.165).

● Grid display

With [Grid 1] or [Grid 2], you can display grid lines.

● Aspect ratio^{*}

The image's aspect ratio can be set to [3:2], [4:3], [16:9], or [1:1]. The following aspect ratios will be indicated with lines on the Live View image: [4:3] [16:9] [1:1].

JPEG images will be saved with the set aspect ratio.

RAW images will always be saved with the [3:2] aspect ratio. Since the aspect ratio information is appended to the RAW image, the image will be generated in the respective aspect ratio when you process the RAW image with the provided software. In the case of the [4:3], [16:9], and [1:1] aspect ratios, the aspect-ratio lines will appear during image playback, but the lines are not actually drawn on the image.

Quality	Aspect Ratio and Pixel Count			
	3:2	4:3	16:9	1:1
L RAW	5184x3456 (18.0 megapixels)	4608x3456 (16.0 megapixels)	5184x2912* (15.1 megapixels)	3456x3456 (11.9 megapixels)
M	3456x2304 (8.0 megapixels)	3072x2304 (7.0 megapixels)	3456x1944 (6.7 megapixels)	2304x2304 (5.3 megapixels)
M RAW	3888x2592 (10.1 megapixels)	3456x2592 (9.0 megapixels)	3888x2188* (8.5 megapixels)	2592x2592 (6.7 megapixels)
S1 S RAW	2592x1728 (4.5 megapixels)	2304x1728 (4.0 megapixels)	2592x1456* (3.8 megapixels)	1728x1728 (3.0 megapixels)
S2	1920x1280 (2.5 megapixels)	1696x1280* (2.2 megapixels)	1920x1080 (2.1 megapixels)	1280x1280 (1.6 megapixels)
S3	720x480 (350,000 pixels)	640x480 (310,000 pixels)	720x400* (290,000 pixels)	480x480 (230,000 pixels)

- For asterisked image-recording quality, the pixel count does not exactly match the set aspect ratio.
- The area displayed for aspect ratios with an asterisk is slightly larger than the recorded area. Check the captured images on the LCD monitor when shooting.
- If you print images shot with the EOS 60D with a 1:1 aspect ratio using direct printing on a different camera, the image might not be correctly printed.

● Exposure simulation [☆]

Exposure simulation displays and simulates how the brightness of the actual image (exposure) will look. The **[Enable]** and **[Disable]** settings are explained below:

● **Enable** (**Exp.SIM**)

The displayed image brightness will be close to the actual brightness (exposure) of the resulting image. If you set exposure compensation, the image brightness will change accordingly.

● **Disable** (**DISP**)

The image is displayed at the standard brightness to make the Live View image easy to see.

- **Silent shooting** [☆]

- **Mode 1**

The shooting operation noise is quieter than with normal shooting. Continuous shooting is also possible. High-speed continuous shooting will be approx. 5 fps.

- **Mode 2**

When you press the shutter button completely, only one shot will be taken. While you keep holding down the shutter button, the camera operation will be suspended. Then when you return to the shutter button's halfway position, the camera operation will resume. The shooting noise is thereby minimized. Even if continuous shooting is set, only a single shot can be taken in this mode.

- **Disable**

If you use a TS-E lens to make **vertical shift movements** or use an Extension Tube, be sure to set this to **[Disable]**. Setting it to **[Mode 1]** or **[Mode 2]** will result in incorrect or irregular exposures. When you press the shutter button completely, the shutter will sound like it took two shots. However, only one shot will be taken.



- If you use flash, the **[Disable]** operation will take effect even if you had set it to **[Mode 1]** or **[Mode 2]**.
- When using a non-Canon flash unit, set it to **[Disable]**. (The flash will not fire if it is set to **[Mode 1]** or **[Mode 2]**.)

- **Metering timer** [☆]

You can change how long the exposure setting is displayed (AE lock time).



If you select **[Dust Delete Data]**, **[Sensor cleaning]**, **[Clear all camera settings]**, or **[Firmware Ver.]**, the Live View shooting will be terminated.

Using AF to Focus

Selecting the AF Mode

The AF modes available are [Live mode], [ Live mode] (face detection, p.161), and [Quick mode] (p.165).

If you want to achieve precise focus, set the lens focus mode switch to <MF>, magnify the image, and focus manually (p.167).

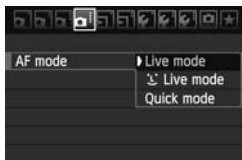

Select the AF mode.



- Under the [] tab, select [AF mode].
- While the Live View image is displayed, you can press the <AF> button to select the AF mode on the setting screen displayed.

Live Mode: AF Live



The image sensor is used to focus. Although AF is possible with the Live View image displayed, **the AF operation will take longer than with the Quick mode**. Also, achieving focus may be more difficult than with the Quick mode.



1 Display the Live View image.

- Press the < > button.
- ▶ The image will appear on the LCD monitor.
- ▶ The AF point < > will appear.

2 Move the AF point.

- You can use < > to move the AF point to where you want to focus (it cannot go to the edges of the picture).
- To return the AF point to the center, press the < > button.

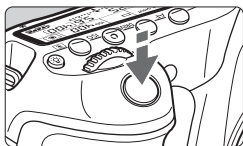

3 Focus the subject.

- Aim the AF point over the subject and press the shutter button halfway.
- ▶ When focus is achieved, the AF point will turn green and the beeper will sound.
- ▶ If focus is not achieved, the AF point will turn orange.



4 Take the picture.

- Check the focus and exposure, then press the shutter button completely to take the picture (p.152).

☺ (Face detection) Live Mode: AF ☺

With the same AF method as the Live mode, human faces are detected and focused. Have the target person face the camera.



1 Display the Live View image.

- Press the <📷> button.
- ▶ The image will appear on the LCD monitor.
- When a face is detected, the <☺> frame will appear over the face to be focused.
- If multiple faces are detected, <☺☺> will be displayed. Use <🔍> to move the <☺> frame over the target face.

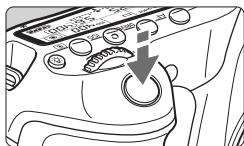

2 Focus the subject.

- Press the shutter button halfway and the camera will focus the face covered by the <[]> frame.
- ▶ When focus is achieved, the AF point will turn green and the beeper will sound.
- ▶ If focus is not achieved, the AF point will turn orange.
- If a face cannot be detected, the AF point <[]> will be displayed and AF will be executed at the center.



3 Take the picture.



- Check the focus and exposure, then press the shutter button completely to take the picture (p.152).

- If the focus is way off, face detection will not be possible. If the lens enables manual focusing even while the lens focus mode switch is set to <AF>, turn the focusing ring to attain rough focus. The face will then be detected and <[]> will be displayed.
- An object other than a human face might be detected as a face.
- Face detection will not work if the face is very small or large in the picture, too bright or too dark, tilted horizontally or diagonally, or partially hidden.
- The <[]> focusing frame might cover only part of the face.

- When you press the <[]> button, the AF mode will switch to the Live mode (p.160). You can press the <[]> to move the AF point. Press the <[]> button again to return to the <[]> (face detection) Live mode.
- Since AF is not possible with a face detected near the edge of the picture, the <[]> will be grayed out. Then if you press the shutter button halfway, the center AF point <[]> will be used to focus.

Live Mode and (Face Detection) Live Mode Notes

AF operation

- Focusing will take slightly longer.
- Even when focus has been achieved, pressing the shutter button halfway will focus again.
- The image brightness may change during and after the AF operation.
- If the light source changes while the Live View image is displayed, the screen might flicker and focusing can be difficult. If this happens, stop the Live View shooting and autofocus under the actual light source first.
- If you press the  button in the Live mode, the image will be magnified at the AF point. If focusing is difficult in the magnified view, return to the normal view and autofocus. Note that the AF speed may differ between the normal and magnified views.
- If you autofocus in the Live mode's normal view and then magnify the image, the focus might be off.
- In the  Live mode, pressing the  button will not magnify the image.



- In the Live mode or  (face detection) Live mode, if you shoot a peripheral subject and it is slightly out of focus, aim the center AF point over the subject to focus, then take the picture.
- The AF-assist beam will not be emitted.

Shooting conditions which can make focusing difficult:

- Low-contrast subjects such as the blue sky and solid-color, flat surfaces.
- Subjects in low light.
- Stripes and other patterns where there is contrast only in the horizontal direction.
- Under a light source whose brightness, color, or pattern keeps changing.
- Night scenes or points of light.
- Under fluorescent lighting or when the image flickers.
- Extremely small subjects.
- Subjects at the edge of the picture.
- Subjects strongly reflecting light.
- The AF point covers both a near and faraway subject (such as an animal in a cage).
- Subjects which keep moving within the AF point and cannot keep still due to camera shake or subject blur.
- A subject approaching or moving away from the camera.
- Autofocusing while the subject is way out of focus.
- Soft focus effect is applied with a soft focus lens.
- A special effects filter is used.



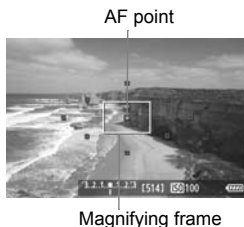

Quick Mode: AFQuick

The dedicated AF sensor is used to focus in the One-Shot AF mode (p.76), using the same AF method as with viewfinder shooting. Although you can focus the target area quickly, **the Live View image will be interrupted momentarily during the AF operation.**

**1 Display the Live View image.**

- Press the <  > button.
- ▶ The image will appear on the LCD monitor.
- The small boxes on the screen are the AF points, and the larger box is the magnifying frame.

**2 Select the AF point. ☆**

- When you press the <  > button, the Quick Control screen will appear.
- ▶ The settable functions will be highlighted in blue.
- Press the <  > key to make the AF point selectable.
- Turn the <  > or <  > dial to select the AF point.

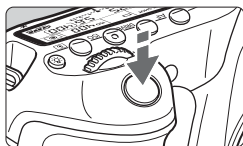

3 Focus the subject.

- Aim the AF point over the subject and press the shutter button halfway.
- ▶ The Live View image will turn off, the reflex mirror will go back down, and AF will be executed.
- ▶ When focus is achieved, the beeper will sound and the Live View image will reappear.
- ▶ The AF point used to focus will light in green.



4 Take the picture.

- Check the focus and exposure, then press the shutter button completely to take the picture (p.152).

 You cannot take a picture during autofocus. Take the picture while the Live View image is displayed.

Focusing Manually

You can magnify the image and focus precisely manually.

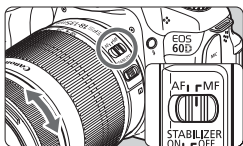

1 Set the lens focus mode switch to <MF>.

- Turn the lens focusing ring to focus roughly.

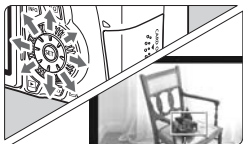

Magnifying frame

2 Move the magnifying frame.

- Use <⬅> to move the magnifying frame to the position where you want to focus.
- To return the magnifying frame to the center, press the <⏏> button.

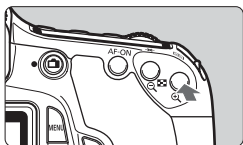

3 Magnify the image.

- Press the <⊕> button.
- ▶ The area within the magnifying frame will be magnified.
- Each time you press the <⊕> button, the view will change as follows:

→ 5x → 10x → Normal view



AE lock

Magnified area position

Magnification

4 Focus manually.

- While looking at the magnified image, turn the lens focusing ring to focus.
- After achieving focus, press the <⊕> button to return to the normal view.

5 Take the picture.

- Check the focus and exposure, then press the shutter button to take the picture (p.152).

Notes About the Live View Image

- Under low- or bright-light conditions, the Live View image might not reflect the brightness of the captured image.
- If the light source within the image changes, the screen might flicker. If this happens, stop the Live View shooting and resume shooting under the actual light source to be used.
- If you point the camera in a different direction, it might throw off the Live View image's correct brightness momentarily. Wait until the brightness level stabilizes before shooting.
- If there is a very bright light source in the picture, such as the sun, the bright area might appear black on the LCD monitor. However, the actual captured image will correctly show the bright area.
- In low light, if you set the [ **LCD brightness**] to a bright setting, chrominance noise may appear in the Live View image. However, the chrominance noise will not be recorded in the captured image.
- When you magnify the image, the image sharpness may look more pronounced than it really is.



Notes About the Shooting Results

- When you shoot continuously with the Live View function for a long period, the camera's internal temperature may increase and it can degrade image quality. Terminate Live View shooting when not shooting images.
- Before taking a long exposure, stop Live View shooting temporarily and wait several minutes before shooting. This is to prevent image degradation.
- Live View shooting in high temperatures and at high ISO speeds may cause noise or irregular colors.
- When you shoot at high ISO speeds, noise (banding, dots of light, etc.) may become noticeable.
- If you take the picture during magnified view, the exposure might not come out as desired. Return to the normal view before taking the picture. During the magnified view, the shutter speed and aperture will be displayed in red. Even if you take the picture during magnified view, the image will be captured in the normal view.
- If the [] **Auto Lighting Optimizer**] (p.101) menu is not set to **[Disable]**, the image may look bright even if a decreased exposure compensation or flash exposure compensation has been set.

Custom Function Notes

- During Live View shooting, certain Custom Function settings will not take effect (p.251).

Notes About Lenses and Flash

- The focus preset feature on super telephoto lenses cannot be used.
- FE lock is not possible when the built-in flash or an external Speedlite is used. The external Speedlite's modeling flash also cannot be used.



8

Shooting Movies



Set the Mode Dial to <[Movie Camera Icon]> to shoot movies. The movie recording format will be MOV.

Cards which can record movies

When shooting movies, use a large-capacity SD card with SD Speed Class 6 “CLASS 6” or higher rating.

If you use a slow-writing card when shooting movies, the movie might not be recorded properly. And if you playback a movie on a card having a slow reading speed, the movie might not playback properly.

To check the card's read/write speed, refer to the card manufacturer's Web site.



About Full HD 1080

Full HD 1080 indicates compatibility with High-Definition featuring 1080 vertical pixels (scanning lines).



Shooting Movies

Connecting the camera to a TV set is recommended to playback movies (p.209, 212).

Autoexposure Shooting



1 Set the Mode Dial to <Movie>.

- ▶ The reflex mirror will make a sound, then the image will appear on the LCD monitor.

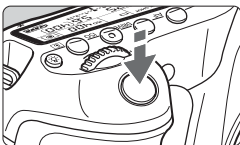

2 Focus the subject.

- Before shooting a movie, autofocus or manual focus (p.160-167).
- When you press the shutter button halfway, the camera will focus with the current AF mode.



3 Shoot the movie.

- Press the <Movie> button to start shooting a movie. To stop movie shooting, press <Movie> again.
- ▶ While the movie is being shot, the "●" mark will be displayed on the upper right of the screen.

Recording movie

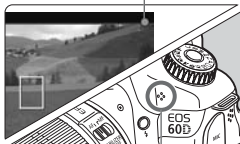





Microphone



- During movie shooting, do not point the lens toward the sun. The sun's heat can damage the camera's internal components.
- **Cautions for movie shooting are on pages 187 and 188.**
- **If necessary, also read the Live View shooting cautions on pages 168 and 169.**



About the White and Red Internal Temperature Warning Icons

- If the camera's internal temperature increases due to prolonged movie shooting or a high ambient temperature, a white  icon will appear. Even if you shoot a movie while this icon is displayed, the movie's image quality will not be affected. However, if you switch to still shooting, the image quality of the still photos may deteriorate. You should stop shooting still photos and allow the camera to cool down.
- If the camera's internal temperature further increases while the white  icon is displayed, a red  icon will start blinking. This blinking icon is a warning that the movie shooting will soon be terminated automatically. If this happens, you will not be able to shoot again until the camera's internal temperature decreases. Turn off the power and let the camera rest for a while.
- Movie shooting at high temperature for a prolonged period will cause the  and  icons to appear sooner. When not shooting, turn off the camera.



- You can also focus by pressing the **<AF-ON>** button.
- AE lock is possible by pressing the **<★>** button (p.122). To cancel AE lock during movie shooting, press the **<☐>** button.
- The ISO speed, shutter speed, and aperture are set automatically.
- By turning the **<☉>** dial, you can set exposure compensation.
- Pressing the shutter button halfway displays the shutter speed and aperture (p.176) on the screen's bottom left. This is the exposure setting for taking a still photo.

Manual Exposure Shooting

You can manually set the shutter speed, aperture, and ISO speed for movie shooting. Using manual exposure to shoot movies is for advanced users.



1 Set the Mode Dial to <Movie>.

- ▶ The reflex mirror will make a sound, then the image will appear on the LCD monitor.



2 Select [Movie exposure].

- Press the <MENU> button and under the [Movie] tab, select [Movie exposure], then press <SET>.



3 Select [Manual].

- Select [Manual], then press <SET>.
- Exit the menu.

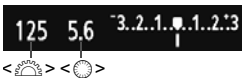

4 Set the shutter speed and aperture.

- To set the shutter speed, turn the <Shutter Speed> dial. The settable shutter speeds depend on the frame rate <Frame Rate>.
 - 1/60 / 1/50 : 1/4000 sec. - 1/60 sec.
 - 1/30 / 1/25 / 1/24 : 1/4000 sec. - 1/30 sec.
- To set the aperture, turn the <Aperture> dial. If it cannot be set, press the <UNLOCK> button (16), then turn the <Aperture> dial.

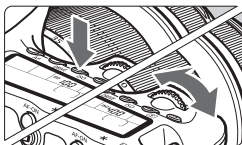

5 Set the ISO speed.

- Press the <ISO> button.
- ▶ The ISO speed setting screen will appear on the LCD monitor.
- Press the <◀▶> key to set the ISO speed.
 - Auto ISO setting : ISO 100 - 6400
 - Manual ISO setting: ISO 100 - 6400

6 Focus and shoot the movie.

- The procedure is the same as steps 2 and 3 for "Autoexposure Shooting" (p.172).



- AE lock and exposure compensation cannot be set.
- Changing the shutter speed or aperture during movie shooting is not recommended since it will record the changes in the exposure.
- If you use a lens whose maximum aperture changes while you zoom, you should not zoom while shooting a movie. Zooming while shooting a movie may record changes in the exposure.
- If you shoot a movie under fluorescent lighting, the movie image might flicker.



- With Auto ISO, the standard movie exposure will usually be obtained even if the light level changes.
- When shooting a movie of a moving subject, a shutter speed of 1/30 sec. to 1/125 sec. is recommended. The faster the shutter speed, the less smooth the subject's movement will look.
- If you playback with "Shooting information display" (p.192) a movie shot with autoexposure, the shutter speed and aperture will not be displayed. The image information (Exif) will record the settings used at the start of the movie shooting.



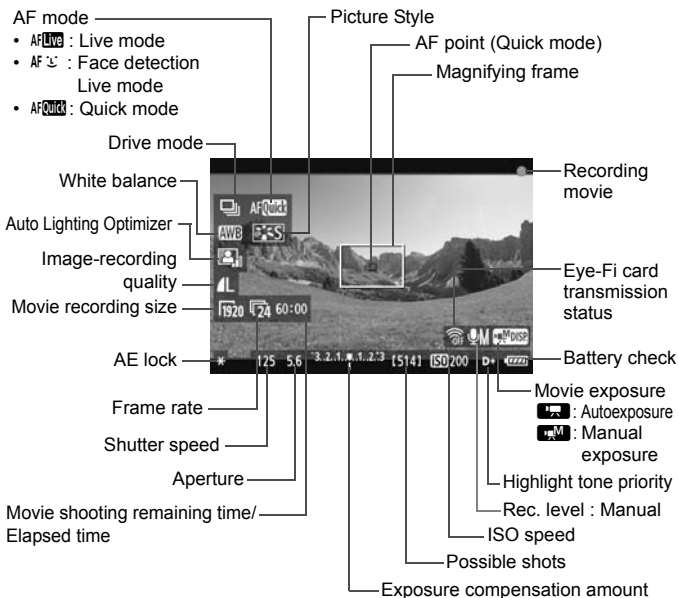

About the Information Display

- Each time you press the **<INFO.>** button, the information display will change.



- You can display the electronic level by pressing the **<INFO.>** button (p.266). When you start shooting a movie, the electronic level will turn off. To display the electronic level again, stop the movie shooting and press the **<INFO.>** button. Note that if the AF mode is set to [**Live mode**] or the camera is connected to a TV set with an HDMI cable (p.209), the electronic level cannot be displayed.
- If there is no card in the camera, the movie shooting remaining time will be displayed in red.
- When movie shooting starts, the movie shooting remaining time will change to the elapsed time.



- One continuous movie will be recorded as one file.
- Monaural sound is recorded by the camera's built-in microphone (p.172).
- Stereo sound recording is possible by connecting an external microphone (commercially available) equipped with a stereo mini plug (3.5mm dia.) to the camera's external microphone IN terminal (p.16).
- Movie-related settings are under the [], [], and [] menu tabs (p.182).
- You can use Remote Controller RC-6 (sold separately, p.126) to start and stop the movie shooting if the drive mode is < > or < >. Set the shooting timing switch to <2> (2-sec. delay), then press the transmit button. If the switch is set to <●> (immediate shooting), still photo shooting will take effect.
- With a fully-charged Battery Pack LP-E6, the total shooting time will be as follows: At 23°C/73°F: Approx. 2 hours, At 0°C/32°F: Approx. 1 hr. 40 min.

Final Image Simulation

The final image simulation reflects the effects of the Picture Style, white balance, etc., in the Live View image so you can see what the captured image will look like. During movie shooting, the Live View image will automatically reflect the settings listed below.

Final image simulation for movies

- Picture Style
 - * All settings such as sharpness, contrast, color saturation, and color tone will be reflected.
- White balance
- Exposure
- Depth of field
- Auto Lighting Optimizer
- Peripheral illumination correction
- Highlight tone priority

Shooting Still Photos

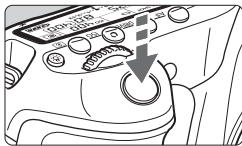

While shooting a movie, you can also take a still photo by pressing the shutter button completely.

Shooting Stills in the <Movie> Mode

- When the movie-recording size is [1920x1080] or [1280x720], the aspect ratio will be 16:9. When the movie-recording size is [640x480], the aspect ratio will be 4:3.
- If you take a still photo during movie shooting, the movie will record a still moment lasting approx. 1 sec.
- The captured still photo will be recorded to the card, and the movie shooting will resume automatically when the Live View image is displayed.
- The card will record the movie and still photo as separate files.
- Functions particular to still shooting are shown below. Other functions will be the same as for movie shooting.

Function	Settings
Image-recording quality	As set in the [Quality] menu.
Exposure setting	Shutter speed and aperture set automatically (or set manually for manual exposures). Displayed when the shutter button is pressed halfway.
AEB	Canceled
Drive mode	All settable*
Flash	Flash off

* The self-timer can be used before you start shooting a movie. If used during movie shooting, the self-timer will switch to single-image shooting.

ⓘ Continuous still photo shooting is possible during movie shooting, but the captured images will not be displayed on the screen. Depending on the still photo's image-recording quality, number of shots during continuous shooting, card performance, etc., movie shooting might stop automatically.

Shooting Function Settings

AF / DRIVE / ISO Settings

You can press the <AF> or <DRIVE> button to display the respective setting screen on the LCD monitor, and press the <◀▶> key to set the function.

For manual exposure (p.174), press the <ISO> button and press the <◀▶> key to set the ISO speed.

Q Quick Control

While the LCD monitor displays an image, pressing the <Q> button will enable you to set the following: **AF mode**, **drive mode (still photos)**, **white balance**, **Picture Style**, **Auto Lighting Optimizer**, **image-recording quality (still photos)**, and movie-recording size. (Functions in bold apply to all shooting modes.)



1 Press the <Q> button.

- ▶ The settable functions will be highlighted in blue.
- When <AFQuick> is selected, the AF points will also be displayed.

2 Select a function and set it.

- Press the <▲▼> key to select a function.
- ▶ The setting of the selected function is displayed at the bottom.
- Turn the <☉> or <☽> dial to change the setting. You can also press the <◀▶> key to change the setting (except for the AF point).

MENU Setting the Movie-recording Size

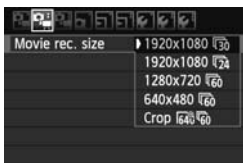

Under the [] tab, the [Movie rec. size] menu enables you to select the movie's image size [***x***] and frame rate [] (frames recorded per second). The [] (frame rate) switches automatically depending on the [Video system] setting.

● Image size

[1920x1080] : Full HD (Full High-Definition) recording quality.

[1280x720] : HD (High-Definition) recording quality.

[640x480] : Standard-definition recording quality. The aspect ratio will be 4:3.

[Crop 640x480] : Standard-definition recording quality. The aspect ratio will be 4:3. It will give a telephoto effect of approx. 7x. This shooting mode is called Movie crop.

● Frame rate (fps: frames per second)

[] [] : For areas where the TV format is NTSC (North America, Japan, Korea, Mexico, etc.).

[] [] : For areas where the TV format is PAL (Europe, Russia, China, Australia, etc.).







[] : Mainly for motion pictures.

ⓘ Notes for Movie crop

- Use a tripod to prevent hand-held camera shake.
- The Movie crop image cannot be magnified for focusing.
- Even if the AF mode has been set to [Quick mode], it will switch automatically to [Live mode] during movie shooting. Also, in [Live mode], the AF point is displayed larger than with other recording sizes.
- Noise and dots of light may be more noticeable than in other recording sizes.
- Focusing may be difficult if the AF point covers both a near and far subject.
- Still photos cannot be taken.

Total Movie Recording Time and File Size Per Minute

Due to file system limitations, if the file size of a single movie clip reaches 4 GB, movie shooting will stop automatically. At [1920x1080] and [1280x720], the maximum recording time of a single movie clip will be approx. 12 min. At [640x480] and [Crop 640x480], the maximum recording time of a single movie clip will be approx. 24 min. To shoot a movie again, press the <  > button. (A new movie file starts being recorded.)

Movie-recording Size		Total Recording Time (approx.)		File Size
		8GB Card	16GB Card	
[1920x1080]		22 min.	44 min.	330 MB/min.
				
				
[1280x720]		22 min.	44 min.	330 MB/min.
				
[640x480] [Crop 640x480]		46 min.	1 hr. 32 min.	165 MB/min.
				



- An increase of the camera's internal temperature may cause movie shooting to stop before the maximum recording time shown above (p.173).
- The maximum recording time of one movie clip is 29 min. 59 sec. Depending on the subject and the increase in the camera's internal temperature, the movie shooting might stop sooner than 29 min. 59 sec.



With ZoomBrowser EX/ImageBrowser (provided software), you can extract a still image from the movie. The still image quality will be as follows: Approx. 2 megapixels at [1920x1080], approx. 1 megapixel at [1280x720], and approx. 300,000 pixels at [640x480].

MENU Menu Function Settings



The menu options under the [M], [M], and [M] tabs are explained below. Note that the settings under the [M], [M], and [M] menu tabs will take effect only when the Mode Dial is set to <M>. They will not take effect when the Mode Dial is set to any another shooting mode.

[M] Menu

- **Movie exposure**

Normally, set this option to **[Auto]**.

Setting **[Movie exposure]** to **[Manual]** enables you to manually set the ISO speed, shutter speed, and aperture for movie shooting (p.174).

- **AF mode**

The AF modes will be the same as described on pages 160-166.

You can select **[Live mode]**, **[L Live mode]**, or **[Quick mode]**. Note that continuous focusing of a moving subject is not possible.

- **AF with shutter button during M (movie recording)**

When **[Enable]** is set, AF is possible during movie shooting.

However, continuous autofocus is not possible. If you autofocus during movie shooting, you might momentarily throw the focus way off or change the exposure.

If the AF mode is **[Quick mode]**, AF will be executed in Live mode.

- **AF and metering buttons for **

You can change the function assigned to the halfway pressing of the shutter button, the AF start button, and the AE lock button. You can assign the following functions to the buttons in one of ten combinations: Metering & AF start, AE lock, metering start, AF stop, and no function.

- ** ISO speed setting increments**

You can set the ISO speed manually in 1/3- or 1-stop increments.

- ** Highlight tone priority**

If **[Enable]** is set, highlight detail will be improved. The dynamic range is expanded from the standard 18% gray to bright highlights. The gradation between the grays and highlights becomes smoother. The settable ISO speed range will be ISO 200-6400. The Auto Lighting Optimizer will also be set automatically to **[Disable]** and cannot be changed.



The AF mode you set will also take effect for Live View shooting (except for **[Crop 640x480]**).

[] Menu

Movie rec. size	1920x1080 30
Sound recording	Auto
Silent shooting	Mode 1
Metering timer	16 sec.
Grid display	Off

● Sound recording

Sound recording	
Sound rec.	Auto
Rec. level	↑-----
Wind filter	Disable
-dB	40 12 0
L	----- ----- -----
R	----- ----- -----
	MENU →

Level meter

Normally, the built-in microphone will record monaural sound. Stereo sound recording is possible by connecting an external microphone equipped with a stereo mini plug (3.5mm dia.) to the camera's external microphone IN terminal (p.16). When an external microphone is connected, sound recording will switch automatically to the external microphone.

[Sound rec.] options

[Auto] : The sound recording level will be adjusted automatically. Auto level control will operate automatically in response to the sound level.

[Manual] : For advanced users. You can adjust the sound recording level to one of 64 levels. Select **[Rec. level]** and look at the level meter while turning the dial to adjust the sound recording level. While looking at the peak hold indicator (Approx. 3 sec.), adjust so that the level meter sometimes lights up the "12" (-12 dB) mark on the right for the loudest sounds. If it exceeds "0," the sound will be distorted.

[Disable] : Sound will not be recorded.

[Wind filter]

If **[Enable]** is set, outdoor wind noise entering the microphone will be reduced. Note that, some low-tone noise might also be reduced. When shooting in places where there is no wind, set this to **[Disable]** for a more natural sound recording.



- The sound volume balance between L (left) and R (right) cannot be adjusted.
- The 48 kHz sampling frequency will be 16-bit recordings for both L and R.

● Silent shooting

This function applies to still photo shooting (p.159).

● Metering timer

You can change how long the exposure setting is to be displayed (AE lock time) when the **< * >** is pressed.

● Grid display

With **[Grid 1 \equiv]** or **[Grid 2 \equiv]**, you can display grid lines.

[:] Menu



- **Exposure compensation**

Although exposure compensation can be set up to ± 5 stops, exposure compensation for movies can be set only up to ± 3 stops. For still photos, exposure compensation can be set up to ± 5 stops.

- **Auto Lighting Optimizer**

The Auto Lighting Optimizer can be set as explained on page 101. It will be applied to both movie shooting and still photos taken during movie shooting.

If the [:] menu tab's [] **Highlight tone priority** is set to **[Enable]**, the Auto Lighting Optimizer will be set automatically to **[Disable]** and cannot be changed.

- **Picture Style**

The Picture Style can be set as explained on pages 90-95. It will be applied to both movie shooting and still photos taken during movie shooting.

- **White balance**

The white balance can be set as explained on pages 96-98. It will be applied to both movie shooting and still photos taken during movie shooting.

- **Custom White Balance**

As explained on page 97, the image for custom white balance can be selected.

Notes on Movie Shooting

Recording and Image Quality

- If the attached lens has an Image Stabilizer, the Image Stabilizer will operate at all times even if you do not press the shutter button halfway. The Image Stabilizer will thereby consume battery power and may shorten the total movie shooting time or decrease the number of possible shots. If you use a tripod or if the Image Stabilizer is not necessary, you should set the IS switch to <OFF>.
- The camera's built-in microphone will also pick up camera operation noise. If you use a commercially-available external microphone, you can prevent (or reduce) these noises from being recorded.
- Do not connect anything other than an external microphone to the camera's external microphone IN terminal.
- Autofocusing during movie shooting is not recommended since it might momentarily throw the focus way off or change the exposure. Even if the AF mode has been set to [Quick mode], it will switch to the Live mode during movie shooting.
- If movie shooting is not possible due to insufficient remaining capacity of the card, the movie recording size and movie shooting remaining time (p.176) will be displayed in red.
- If you use a card having a slow writing speed, a five-level indicator might appear on the right of the screen during movie shooting. It indicates how much data has not yet been written to the card (remaining capacity of the internal buffer memory). The slower the card, the faster the indicator will climb upward. If the indicator becomes full, movie shooting will stop automatically.

If the card has a fast writing speed, the indicator will either not appear or the level (if displayed) will hardly go upward.

First, shoot a few test movies to see if the card can write fast enough.

If you take still photos during movie shooting, the movie shooting might stop. Setting a low image-recording quality for still images might resolve this problem.



Indicator

Notes on Movie Shooting

Playback and TV connection

- If the brightness changes during autoexposure movie shooting, that part might look momentarily still when you playback the movie. In such cases, shoot movies with manual exposure.
- If you connect the camera to a TV set with an HDMI cable (p.209) and shoot a movie in [1920x1080] or [1280x720], the movie being shot will be displayed at a small size on the TV. However, the actual movie will be properly recorded at the movie recording size that was set.
- If you connect the camera to a TV set (p.209, 212) and shoot a movie, the TV will not output any sound during the shooting. However, the sound will be properly recorded.

9

Image Playback

This chapter explains how to playback and erase photos and movies, how to display images on a TV screen, and other playback-related functions.

About images taken with another camera:

The camera might not be able to properly display images captured with a different camera or edited with a computer or whose file name was changed.

▶ Image Playback

Single Image Display



1 Playback the image.

- Press the <▶> button.
- ▶ The last captured image or last image viewed will appear.



2 Select the image.

- To playback images starting with the last image, turn the <◂> dial counterclockwise.
- To playback images starting with the first captured image, turn the dial clockwise.
- Each time you press the <INFO.> button, the display format will change.



No information



With basic information

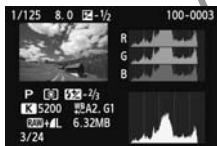

Histogram



With detailed information

3 Exit the image playback.

- Press the <▶> button to exit the image playback and return to shooting-ready state.

INFO. Shooting Information Display

Sample of Image Taken in a Creative Zone Mode

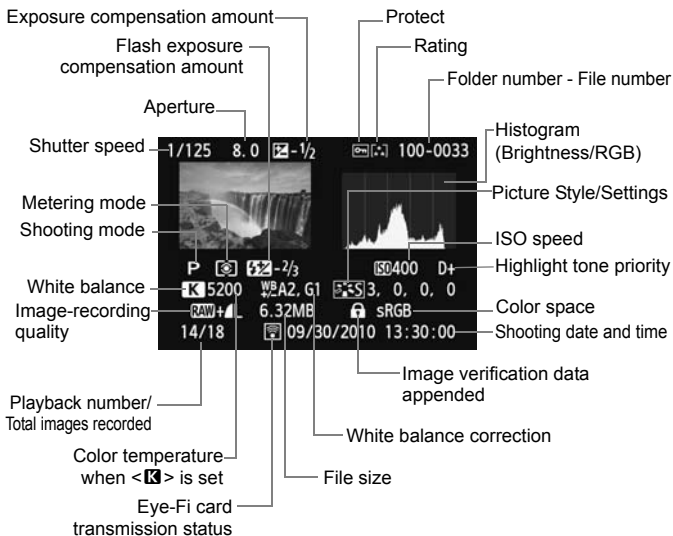

* When you shoot in RAW+JPEG image quality, the RAW image file size will be displayed.

* For still photos taken during movie shooting, <[Movie]> will be displayed.

* For RAW images processed with the camera and images applied with Creative filters, the <RAW+> icon changes to <[Creative Filter]>.

Sample of Image Taken in a Basic Zone Mode

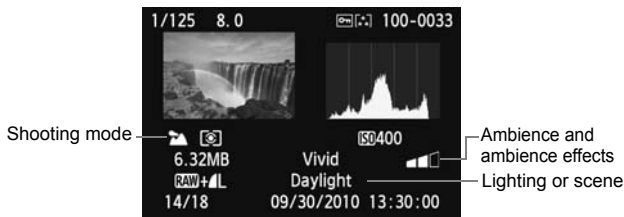

* For images taken in Basic Zone modes, the information displayed may differ depending on the shooting mode.

Sample of Movie Taken in Movie Mode

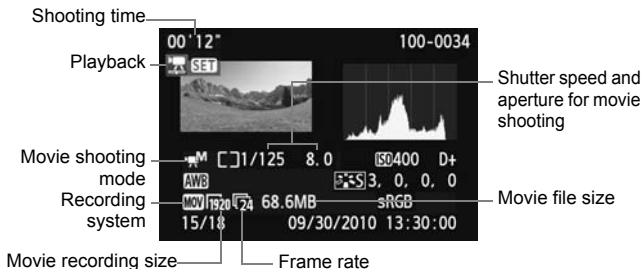

● About the Highlight Alert

When the [Highlight alert] menu option is set to [Enable], overexposed highlight areas will blink. To obtain more image detail in the overexposed areas, set the exposure compensation to a negative amount and shoot again.

- **About the AF Point Display**

When the the [ **AF point disp.**] menu option is set to [**Enable**], the AF point which achieved focus will be displayed in red. If automatic AF point selection was used, multiple AF points may be displayed in red.

- **About the Histogram**

The brightness histogram shows the exposure level distribution and overall brightness. The RGB histogram is for checking the color saturation and gradation. The display can be switched with the [ **Histogram**] menu option.

[Brightness] Display

This histogram is a graph showing the distribution of the image's brightness level. The horizontal axis indicates the brightness level (darker on the left and brighter on the right), while the vertical axis indicates how many pixels exist for each brightness level. The more pixels there are toward the left, the darker the image. And the more pixels there are toward the right, the brighter the image. If there are too many pixels on the left, the shadow detail will be lost. And if there are too many pixels on the right, the highlight detail will be lost. The gradation in-between will be reproduced. By checking the image and its brightness histogram, you can see the exposure level inclination and the overall gradation.

Sample Histograms



Dark image



Normal brightness



Bright image

[RGB] Display

This histogram is a graph showing the distribution of each primary color's brightness level in the image (RGB or red, green, and blue). The horizontal axis indicates the color's brightness level (darker on the left and brighter on the right), while the vertical axis indicates how many pixels exist for each color brightness level. The more pixels there are toward the left, the darker and less prominent the color. And the more pixels there are toward the right, the brighter and denser the color. If there are too many pixels on the left, the respective color information will be lacking. And if there are too many pixels on the right, the color will be too saturated with no detail. By checking the image's RGB histogram, you can see the color's saturation and gradation condition and white balance inclination.

▶ Searching for Images Quickly

▣ Display Multiple Images on One Screen (Index display)

Search for images quickly with the index display showing four or nine images on one screen.



1 Switch to the index display.

- During image playback, press the <▣·Q> button.
- ▶ The 4-image index display will appear. The currently-selected image will be highlighted in a blue frame.
- Press the <▣·Q> button again to switch to the 9-image index display. Pressing the <Q> button will switch the display from 9 images, 4 images, to a single image displayed.



2 Select the image.



- Turn the <☉> dial to move the blue frame to select the image. You can also press the <▲▼> or <◀▶> key to select the image.
- Turn the <⚙> dial to see the next screen of index images.
- Press <SET> and the selected image will be displayed as a single image.









Jump through Images (Jump display)

With the single image display, you can turn the <  > dial to jump through the images.



1 Select the jump method.

- In the [ Image jump w/ ] menu, select the jump method, then press <  >.



- : Display images one by one
 - : Jump 10 images
 - : Jump 100 images
 - : Display by date
 - : Display by folder
 - : Display movies only
 - : Display stills only
 - : Display by image rating (p.198)
- Turn the <  > dial to select the rating.





Jump method

Playback position

2 Browse by jumping.

- Press the <  > button to playback images.
- On the single-image display, turn the <  > dial.
- ▶ The jump display will proceed according to the selected jump method.





- To search images according to the shooting date, select [**Date**]. Turn the <  > dial to display the shooting date.
- To search images according to folder, select [**Folder**].
- If the card contains both [**Movies**] and [**Stills**], select either one to display only movies or stills.
- If no images match the selected [**Rating**], browsing through the images with <  > is not possible.

Magnified View

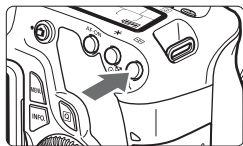
You can magnify a shot image by 1.5x to 10x on the LCD monitor.



1 Magnify the image.



- During image playback, press the  button.
- ▶ The image will be magnified.
- If you hold down the  button, the image will be magnified until it reaches the maximum magnification.
- Press the  button to reduce the magnification. If you hold down the button, the magnification will be reduced to the single image display.





Magnified area position



2 Scroll around the image.

- Use  to scroll around the magnified image.
- To exit the magnified display, press the  button and the single image display will return.





-  ● You can turn the  dial to view another image while the magnification is maintained.
- Magnified view is not possible during the image review immediately after the image is taken.
- A movie cannot be magnified.

Rotating the Image

You can rotate the displayed image to the desired orientation.



1 Select [Rotate].

- Under the [] tab, select [**Rotate**], then press < >.



2 Select the image.







- Turn the < > dial to select the image to be rotated.
- You can also select an image on the index display.



3 Rotate the image.

- Each time you press < >, the image will rotate clockwise as follows: 90° → 270° → 0°
- To rotate another image, repeat steps 2 and 3.
- To exit and return to the menu, press the <MENU> button.



- If you have set [ **Auto rotate**] to [**On**  ] (p.218) before taking vertical shots, you need not rotate the image as described above.
- If the rotated image is not displayed in the rotated orientation during image playback, set the [ **Auto rotate**] menu option to [**On**  ].
- A movie cannot be rotated.

MENU Setting Ratings

With the [Rating] menu, you can give one of five ratings ([★], [☆], [☆☆], [☆☆☆], [☆☆☆☆]) to images and movies.



1 Select [Rating].

- Select the [Rating] menu, then press <SET>.



2 Select an image or movie.

- Turn the <DIAL> dial to select the image or movie to be rated.
- You can display three images by pressing the <DISP> button. To return to the single-image display, press the <DISP> button.





3 Rate the image or movie.

- Press the <▲▼> key to select a rating mark.
- ▶ The total number of images and movies rated will be counted for each rating.
- To rate another image or movie, repeat steps 2 and 3.
- To exit and return to the menu, press the <MENU> button.











The number of images and movies for each rating will be counted up to 3 digits (999). If rated images reaches 1000 or higher, [###] will be displayed.

Taking advantage of ratings

- With the [ **Image jump w/ **] menu, you can display only the rated images and movies.
- With the [ **Slide show**] menu, you can playback only the rated images and movies.
- With the provided software, you can select only the rated images and movies.
- With Windows Vista and Windows 7, you can check the rating with the file information display or the provided image viewer.

Quick Control During Playback

When you press the **<Q>** button during playback, you can set the following: **[ Protect Images**, **[ Rotate**, **[ Rating**, **[ Creative filters**, **[ Resize** (JPEG images only), **[ Highlight alert**, **[ AF point display**, and **[ Image jump w/ **]. For movies, only the functions in bold above can be set.



1 Press the **<Q>** button.

- During image playback, press the **<Q>** button.
- ▶ The Quick Control screen will appear.

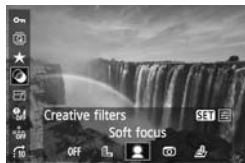





2 Select a function and set it.

- Press the **<▲▼>** key to select a function.
- ▶ The name and current setting of the selected function are displayed at the bottom.
- Press the **<◀▶>** key to set the function.
- For Creative filters and Resize, press **<SET>** and set the function. For details, see page 220 for Creative filters and page 222 for Resize. To cancel, press the **<MENU>** button.

3 Exit the setting.

- Press the **<Q>** button to turn off the Quick Control screen.

 To rotate an image, set the [ **Auto rotate**] menu to [**On**  ]. If it is set to any other setting, the image will not rotate.

-  ● If you shoot in RAW+JPEG image quality, the RAW image will be displayed.
- Pressing the <Q> button during the index display will switch to the single-image display and the Quick Control screen will appear. Pressing the <Q> button again will return to the index display.
- Regarding images not taken with the EOS 60D, selectable functions may be limited.

Enjoying Movies

Basically, you can playback movies in the following three ways:

Playback on a TV set (p.209, 212)

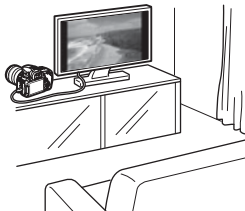

Use the provided AV cable or an HDMI Cable HTC-100 (sold separately) to connect the camera to a TV set. Then you can playback the captured movies and photos on the TV.

If you have a High-Definition TV set and connect your camera with an HDMI cable, you can watch Full HD (Full High-Definition: 1920x1080) and HD (High-Definition: 1280x720) movies with higher image quality.

- Movies on a card can be played only by devices compatible with MOV files.
- Since hard disk recorders do not have an HDMI IN terminal, the camera cannot be connected with an HDMI cable.
- Even if the camera is connected to a hard disk recorder with a USB cable, movies and photos cannot be played nor saved.

Playback on the Camera's LCD Monitor (p.204-208)

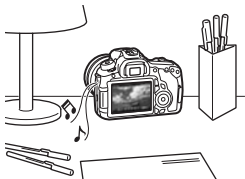

You can playback movies on the camera's LCD monitor and even edit out the first and last scenes. You can also playback the photos and movies recorded in the card as an automatic slide show.

! A movie edited with a personal computer cannot be rewritten to the card and played back with the camera.

Playback and Editing with a Personal Computer

(See the PDF file instruction manual for ZoomBrowser EX/ImageBrowser)



The movie files recorded in the card can be transferred to a personal computer and played or edited with ZoomBrowser EX/ImageBrowser (provided software). You can also extract a single frame from a movie and save it as a still photo.

- !** To have the movie playback smoothly on a personal computer, the personal computer must be a high-performance model. Regarding the hardware requirements for ZoomBrowser EX/ImageBrowser, see the PDF file instruction manual.
- If you want to use commercially-available software to playback or edit the movies, be sure it is compatible with MOV files. For details on commercially-available software, inquire the software maker.

▶ **Playing Movies**



1 Playback the image.

- Press the <▶> button to display the images.



2 Select a movie.

- Turn the <◉> dial to select the movie to be played.
- With the single-image display, the <▶ SET> icon displayed on the upper left indicates that it is a movie.
- On the index display, the perforation on the left edge of the image indicates that it is a movie. **As movies cannot be played on the index display, press <SET> to switch to the single-image display.**



3 On the single-image display, press <SET>.

- ▶ The movie playback panel will appear on the bottom.









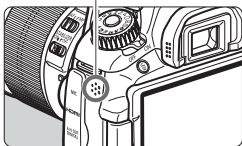











4 Playback the movie.

- Select [▶] (Play), then press <SET>.
- ▶ The movie will start playing.
- You can pause the movie playback by pressing <SET>.
- During movie playback, you can adjust the sound volume by turning the <◉> dial.
- For more details on the playback procedure, see the next page.

Speaker



Function	Playback Description
 Exit	Returns to the single-image display.
 Play	Pressing <  > toggles between play and stop.
 Slow motion	Adjust the slow motion speed by pressing the <   > key. The slow-motion speed is indicated on the upper right.
 First frame	Displays the movie's first frame.
 Previous frame	Each time you press <  >, a single previous frame is displayed. If you hold down <  >, it will rewind the movie.
 Next frame	Each time you press <  >, the movie will play frame-by-frame. If you hold down <  >, it will fast forward the movie.
 Last frame	Displays the movie's last frame.
 Edit	Displays the editing screen (p.206).
	Playback position
mm' ss"	Playback time
 Volume	You can adjust the built-in speaker's (p.204) sound volume by turning the <  > dial.



- With a fully-charged Battery Pack LP-E6, the continuous playback time will be approx. 4 hours at 23°C/73°F.
- During the single-image display, press the < **INFO.** > button to switch the shooting information display (p.266).
- If you took a still photo while you shot the movie, the still photo will be displayed for approx. 1 sec. during the movie playback.
- If you connect the camera to a TV set (p.209, 212) to playback a movie, adjust the sound volume with the TV set. (Turning the <  > dial will not adjust the sound volume.)

✂ Editing the Movie's First and Last Scenes

You can edit out the first and last scenes of a movie in 1-sec. increments.



1 On the movie playback screen, select [✂].

- ▶ The editing screen will be displayed.



2 Specify the part to be edited out.

- Select either [✂] (Cut beginning) or [✂] (Cut end), then press <SET>.
- Press the <◀▶> key to fast forward or turn the <◉> dial (next frame) to specify the part to be edited out, then press <SET>.
- After deciding which part to edit out, press <SET>. The portion highlighted in blue on the top of the screen is what will remain.



3 Check the edited movie.

- Select [▶] and press <SET> to playback the portion highlighted in blue.
- To change the editing, go back to step 2.
- To cancel the editing, select [↶] and press <SET>.



4 Save the movie.

- Select [💾], then press <SET>.
- ▶ The save screen will appear.
- To save it as a new movie, select **[New file]**. To save it and overwrite the original movie file, select **[Overwrite]**. Then press <SET>.

- Since the editing is done in 1-sec. increments (position indicated by [✂]), the exact position where the movie is edited may differ slightly from the position you specified.
- If the card does not have enough room, **[New file]** will not be selectable.
- More movie editing functions are available with ZoomBrowser EX/ImageBrowser (provided software).

MENU Slide Show (Auto Playback)

You can playback the images in the card as an automatic slide show.



1 Select [Slide show].

- Under the [] tab, select [Slide show], then press <SET>.

Number of images to be played



2 Select the images to be played.

- Press the <▲> key to select the desired option, then press <SET>.

[All images/Movies/Stills]

- Press the <▲> key to select one of the following: [All images/ Movies/ Stills]. Then press <SET>.

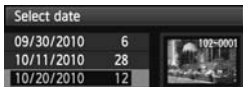

[Date/Folder/Rating]

- Press the <▲> key to select one of the following: [Date/ Folder/ Rating].
- When <INFO. > is highlighted, press the <INFO.> button.
- Press the <▲> key to select the desired option, then press <SET>.



Item	Playback Description
[All images]	All the still photos and movies in the card will be played back.
[Date]	Still photos and movies taken on the selected shooting date will be played back.
[Folder]	Still photos and movies in the selected folder will be played back.
[Movies]	Only the movies in the card will be played back.
[Stills]	Only the still photos in the card will be played back.
[★ Rating]	Only the still photos and movies with the selected rating will be played back.



3 Set [Set up] as desired.

- Press the <▲▼> key to select [**Set up**], then press <SET>.
- Set the [**Display time**] (still photos), [**Repeat**], and [**Transition effect**] options, then press the <MENU> button.

[Display time]



[Repeat]

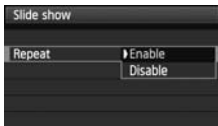

[Transition effect]

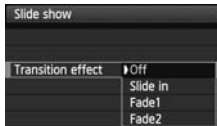

4 Start the slide show.

- Press the <▲▼> key to select [**Start**], then press <SET>.
- ▶ After [**Loading image...**] is displayed, the slide show will start.

5 Quit the slide show.

- To quit the slide show and return to the setting screen, press the <MENU> button.

- To pause the slide show, press <SET>. During pause, [||] will be displayed on the upper left of the image. Press <SET> again to resume the slide show.
- During auto playback, you can press the <INFO> button to change the still photo display format.
- During movie playback, you can adjust the sound volume by turning the <SOUND>.
- During pause, you can turn the <DIAL> to view another image.
- During the slide show, auto power off will not take effect.
- The display time may vary depending on the image.
- To view the slide show on a TV set, see pages 209-212.

Viewing the Images on TV

You can also view the still photos and movies on a TV set. Before connecting or disconnecting the cable between the camera and television, turn off the camera and television.

* Adjust the movie's sound volume with the TV set.

* Depending on the TV set, part of the image displayed might be cut off.

Viewing on HD (High-Definition) TV Sets

The HDMI Cable HTC-100 (sold separately) is required.

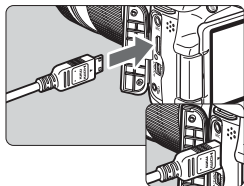

1 Connect the HDMI cable to the camera.

- With the plug's <▲HDMI MINI> logo facing the back of the camera, insert it into the <HDMI OUT> terminal.

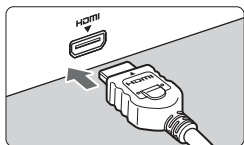

2 Connect the HDMI cable to the TV set.

- Connect the HDMI cable to the TV's HDMI IN port.

3 Turn on the TV and switch the TV's video input to select the connected port.

4 Set the camera's power switch to <ON>.

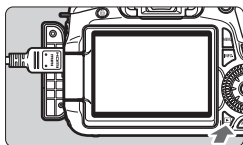

5 Press the <▶> button.

- ▶ The image will appear on the TV screen. (Nothing will be displayed on the camera's LCD monitor.)
- The images will be displayed at the TV's optimum resolution automatically.
- By pressing the <INFO.> button, you can change the display format.
- To playback movies, see page 204.



- Do not connect any other device's output to the camera's <HDMI OUT> terminal. Doing so may cause a malfunction.
- Some TVs might not be able to display the captured images. In such a case, use the provided AV cable to connect to the TV.
- The camera's <A/V OUT> terminal and <HDMI OUT> terminal cannot be used at the same time.

For HDMI CEC TV sets

When a TV set compatible with HDMI CEC* is connected to the camera with the HDMI cable, you can use the TV set's remote control for playback operations.

* An HDMI-standard function enabling you to control multiple HDMI devices with one remote control unit.



1 Select [Ctrl over HDMI].

- Under the [] tab, select [**Ctrl over HDMI**], then press <SET>. Select [**Enable**], then press <SET>.
- ▶ When the camera is connected to a TV set, the TV set's input will automatically switch to the HDMI port connected to the camera. When you press the camera's <▶> button, you can use the TV set's remote control for playback operations.

Still photo playback menu



Movie playback menu



- : Return
- : 9-image index
- : Slide show
- INFO.** : Disp. shooting info
- : Rotate
- : Play movie

2 Select an image or movie.

- Point the remote control to the TV set and press the ←/→ button to select the image. Then press the Enter button.
- ▶ The menu will appear. The menu displayed will differ for still photos and movies.
- Press the ←/→ button to select the desired option, then press the Enter button.
- ▶ For a slide show, press the remote control's ↑/↓ button to select an option, then press the Enter button.
- If you select [**Return**] and press the Enter button, the menu will disappear and you can use the ←/→ button to select an image.



- Some TV sets require you to first enable the HDMI CEC connection. For details, see the TV set's instruction manual.
- Certain TV sets, even those compatible with HDMI CEC, may not operate properly. In such a case, disconnect the HDMI cable, set the camera's [] **Ctrl over HDMI** menu to [**Disable**], and use the camera to control the playback operation.

Viewing on Non-HD (High-Definition) TV Sets

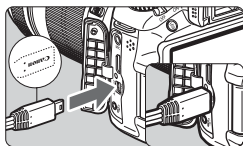

1 Connect the provided AV cable to the camera.

- With the plug's <Canon> logo facing the front of the camera, insert it into the <A/V OUT> terminal.

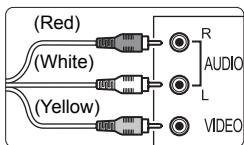

2 Connect the AV cable to the TV set.

- Connect the AV cable to the TV's video IN terminal and audio IN terminal.

3 Turn on the TV and switch the TV's video input to select the connected port.

4 Set the camera's power switch to <ON>.

5 Press the <▶> button.

- ▶ The image will appear on the TV screen (Nothing will be displayed on the camera's LCD monitor).
- To playback movies, see page 204.

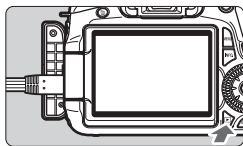

- Do not use any AV cable other than the one provided. Images might not be displayed if you use a different cable.
- If the video system format does not match the TV's, the images will not be displayed properly. Set the proper video system format with the [▶ Video system] menu option.

Protecting Images

Protecting an image prevents it from being erased accidentally.





- 1 Select [Protect images].**
- Under the [] tab, select [**Protect images**], then press <SET>.
 - ▶ The protect setting screen will appear.



- 2 Select the image and protect it.**
- Select [**Select images**], then press <SET>.
 - Turn the < > dial to select the image to be protected, then press <SET>.

Image protect icon



- ▶ When an image is protected, the < > icon will appear on the top of the screen.
- To cancel the image protection, press <SET> again. The < > icon will disappear.
- To protect another image, repeat step 2.
- To exit the image protection, press the <MENU> button. The menu will reappear.

MENU Protecting All Images in a Folder or Card

You can protect all the images in a folder or card at one time.



When the [] **Protect images**] menu option is set to [**All images in folder**] or [**All images on card**], all the images in the folder or card will be protected. To cancel the image protection, select [**Unprotect all images in folder**] or [**Unprotect all images on card**].

 **If you format the card (p.48), the protected images will also be erased.**

-  ● Movies can also be protected.
- Once an image is protected, it cannot be erased by the camera's erase function. To erase a protected image, you must first cancel the protection.
- If you erase all the images (p.216), only the protected images will remain. This is convenient when you want to erase unnecessary images all at once.

Erasing Images

You can either select and erase images one by one or erase them in one batch. Protected images (p.213) will not be erased.

- 1 **Once an image is erased, it cannot be recovered. Make sure you no longer need the image before erasing it. To prevent important images from being erased accidentally, protect them. Erasing a RAW+JPEG image will erase both the RAW and JPEG images.**

Erasing a Single Image

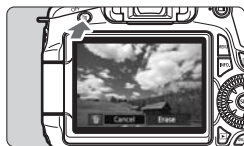

- 1 **Playback the image to be erased.**

- 2 **Press the  button.**

- ▶ The erase dialog will appear at the bottom of the screen.



- 3 **Erase the image.**



- Select **[Erase]**, then press . The image displayed will be erased.

MENU Checkmarking Images to be Erased in a Batch

By checkmarking the images to be erased, you can erase multiple images at one time.



- 1 **Select **[Erase images]**.**

- Under the  tab, select **[Erase images]**, then press .

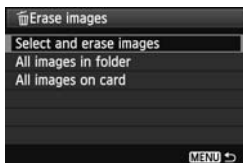

2 Select [Select and erase images].

- Select [**Select and erase images**], then press <SET>.
- ▶ The images will be displayed.
- To display the three-image display, press the <[Grid]•Q> button. To return to the single-image display, press the <Q> button.



3 Select the images to be erased.

- Turn the <Dial> dial to select the image to be erased, then press the <▲▼> key.
- ▶ A <✓> checkmark will be displayed on the upper left.
- To select other images to be erased, repeat step 3.

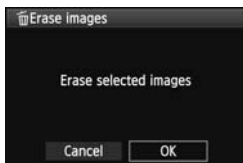

4 Erase the images.

- Press the <[Trash]> button.
- Select [**OK**], then press <SET>.
- ▶ The selected images will be erased.

MENU Erasing All Images in a Folder or Card

You can erase all the images in a folder or card at once. When the [**Erase images**] menu option is set to [**All images in folder**] or [**All images on card**], all the images in the folder or card will be erased.



To also erase protected images, format the card (p.48).

Changing Image Playback Settings

MENU Adjusting the LCD Monitor Brightness

You can adjust the brightness of the LCD monitor to make it easier to read.



1 Select [LCD brightness].

- Under the [] tab, select [**LCD brightness**], then press <SET>.



2 Adjust the brightness.

- While referring to the gray chart, press the <◀▶> key to adjust the brightness, then press <SET>.

To check the image's exposure, looking at the histogram is recommended (p.193).

MENU Auto Rotation of Vertical Images



Vertical images are rotated automatically so they are displayed vertically on the camera's LCD monitor and computer instead of horizontally. The setting of this feature can be changed.

1 Select [Auto rotate].

- Under the [**Y**] tab, select [**Auto rotate**], then press < (SET) >.

2 Set the auto rotation.

- Select the desired setting, then press < (SET) >.



- **On**  

The vertical image is automatically rotated on both the camera's LCD monitor and on the personal computer.

- **On** 

The vertical image is automatically rotated only on the personal computer.

- **Off**

The vertical image is not rotated.

 Auto rotation will not work with vertical images captured while auto rotation was [**Off**]. They will not rotate even if you later switch it to [**On**] for playback.

-  Immediately after image capture, the vertical image will not be automatically rotated for the image review.
- If the vertical image is taken while the camera is pointed up or down, the image might not be rotated automatically for playback.
- If the vertical image is not automatically rotated on the personal computer screen, it means the software you are using is unable to rotate the image. Using the provided software is recommended.

10

Post-Processing Images

After shooting images, you can apply Creative filters or resize the image (downsize the pixel count). You can also process RAW images with the camera.



- It may not be possible to process images shot with a camera other than the EOS 60D.
- Post-processing images as described in this chapter cannot be done while the camera is connected to a personal computer via the <DIGITAL> terminal.

Creative Filters

You can apply the following Creative filters to an image and save it as a new image: Grainy B/W, Soft focus, Toy camera effect, and Miniature effect. Creative filters cannot be applied to **M RAW** and **S RAW** images.



1 Select [Creative filters].

- Select the [ Creative filters] menu option, then press <SET>.
- ▶ Images will be displayed.



2 Select an image.

- Select the image you want to apply a filter to.
- By pressing the <-Q> button, you can switch to the index display and select an image.



3 Select a filter.

- When you press <SET>, the filters will be displayed.
- Press the <◀▶> key to select a filter, then press <SET>.
- ▶ The image applied with the respective filter will be displayed.



4 Adjust the filter effect.

- Press the <◀▶> key to adjust the filter effect, then press <SET>. For the miniature effect, press the <▲▼> key and select the image area (within the white frame) where you want it to look sharp. Then press <SET>.







5 Save the image.

- Select **[OK]** to save the image.
- Note the destination folder and image file number, then select **[OK]**.
- To apply a filter to another image, repeat steps 2 to 5.
- To exit and return to the menu, press the **<MENU>** button.



- With **RAW**+JPEG images, the **RAW** image will be applied with the Creative filter and saved as a JPEG image.
- With **M RAW**+JPEG and **S RAW**+JPEG images, the Creative filter will be applied to the JPEG image.

Creative Filter Features

-  **Grainy B/W**
Makes the image grainy and black and white. By adjusting the contrast, you can change the black-and-white effect.
-  **Soft focus**
Gives the image a soft look. By adjusting the blur, you can change the degree of softness.
-  **Toy camera effect**
Gives a color cast typical of toy cameras and darkens the image's four corners. By adjusting the color tone, you can change the color cast.
-  **Miniature effect**
Creates a diorama effect. In step 4, you can press the **<INFO.>** button to change the orientation (vertical/horizontal) of the white frame that shows where you want the image to look sharp.

Resize

You can resize an image to make the pixel count lower and save it as a new image. Resizing an image is possible only with JPEG **L/M/S1/S2** images. JPEG **S3** and RAW images cannot be resized.



1 Select [Resize].

- Select the [] **Resize**] menu option, then press <SET>.
- ▶ Images will be displayed.



2 Select an image.

- Select the image you want to resize.
- By pressing the <-Q> button, you can switch to the index display and select an image.



Target sizes

3 Select the desired image size.

- Press <(SET)> to display the image sizes.
- Press the <◀▶> key to select the desired image size, then press <(SET)>.



4 Save the image.

- Select [**OK**] to save the image.
- Note the destination folder and image file number, then select [**OK**].
- To resize another image, repeat steps 2 to 4.
- To exit and return to the menu, press the <MENU> button.

Resize Options According to Original Image Size

Original Image Size	Available Resize Settings			
	M	S1	S2	S3
L	<input type="radio"/>	<input type="radio"/>	<input type="radio"/>	<input type="radio"/>
M		<input type="radio"/>	<input type="radio"/>	<input type="radio"/>
S1			<input type="radio"/>	<input type="radio"/>
S2				<input type="radio"/>
S3				

About Image Sizes

The [8.0M 3456x2304] image size displayed in step 3 has a 3:2 aspect ratio. The image size according to aspect ratios is shown in the table below. For asterisked image-recording quality, the pixel count does not exactly match the aspect ratio. The image will be slightly cropped.

Quality	Aspect Ratio and Pixel Count			
	3:2	4:3	16:9	1:1
M	3456x2304 (8.0 megapixels)	3072x2304 (7.0 megapixels)	3456x1944 (6.7 megapixels)	2304x2304 (5.3 megapixels)
S1	2592x1728 (4.5 megapixels)	2304x1728 (4.0 megapixels)	2592x1456* (3.8 megapixels)	1728x1728 (3.0 megapixels)
S2	1920x1280 (2.5 megapixels)	1696x1280* (2.2 megapixels)	1920x1080 (2.1 megapixels)	1280x1280 (1.6 megapixels)
S3	720x480 (350,000 pixels)	640x480 (310,000 pixels)	720x400* (290,000 pixels)	480x480 (230,000 pixels)

RAW↓ JPEG↓ Processing RAW Images with the Camera ☆

You can process **RAW** images with the camera and save them as JPEG images. While the RAW image itself does not change, you can process the RAW image according to different conditions to create any number of JPEG images from it.

Note that **M RAW** and **S RAW** images cannot be processed with the camera. Use Digital Photo Professional (provided software) to process those images.



1 Select [RAW image processing].

- Select the [**RAW image processing**] menu option, then press **<SET>**.
- ▶ **RAW** images will be displayed.



2 Select an image.

- Select the image you want to process.
- By pressing the **<RAW-Q>** button, you can switch to the index display and select an image.



3 Process the image.

- Press **<SET>** and soon the RAW-processing options will appear (p.226, 227).
- Press the **<▲▼>** **<◀▶>** key to select an option, and turn the **<DISP>** dial to change the setting.
- ▶ The displayed image will reflect “Brightness,” “White balance,” and the others settings adjustment.
- To return to the image settings at the time of shooting, press the **<INFO.>** button.



Displaying the setting screen

- Press $\langle \text{SET} \rangle$ to display the setting screen. Turn the $\langle \text{Sun} \rangle$ or $\langle \text{Sun} \rangle$ dial to change the setting. To return to the screen in step 3, press $\langle \text{SET} \rangle$.

4 Save the image.

- Select $[\text{Save}]$ (Save), then press $\langle \text{SET} \rangle$.
- Select $[\text{OK}]$ to save the image.
- Note the destination folder and image file number, then press $[\text{OK}]$.
- ▶ The screen in step 2 will reappear.
- To process another image, repeat steps 2 to 4.
- To exit and return to the menu, press the $\langle \text{MENU} \rangle$ button.

About the Magnified Display

Pressing the $\langle \text{Magnify} \rangle$ button in step 3 will magnify the image. The magnification will differ depending on the pixel count of **[Quality]** set in **[RAW image processing]**. With $\langle \text{Magnify} \rangle$, you can scroll around the magnified image. When **[Magnify]** is grayed out during the image processing, the image cannot be magnified.

While the image is magnified, pressing the $\langle \text{Exit Magnify} \rangle$ button will exit the magnified view.

Images with Aspect Ratio Setting



Images shot in a Live View shooting aspect ratio (**[4:3]** **[16:9]** **[1:1]**) will be displayed in the respective aspect ratio. JPEG images will also be saved in the set aspect ratio.

RAW Image-processing Options





-  **Brightness**

You can adjust the image brightness up to ± 1 stop in 1/3-stop increments. The displayed image will reflect the setting's effect.

-  **White balance** (p.96)

You can select the white balance. If you select [], use the  dial to set the color temperature. The displayed image will reflect the setting's effect.



-  **Picture Style** (p.90)

You can select the Picture Style. To set the parameters such as Sharpness, press  to display the setting screen. Turn the  dial to select a parameter, then turn the  dial to set it as desired. Press  to finalize the setting and to return to the setting screen. The displayed image will reflect the setting's effect.

-  **Auto Lighting Optimizer** (p.101)

You can set the Auto Lighting Optimizer. The displayed image will reflect the setting's effect.

-  **High ISO speed noise reduction** (p.254)

You can set the noise reduction for high ISO speeds. The displayed image will reflect the setting's effect. If the effect is difficult to discern, press the  button to magnify the image. (Press the  button to return to the normal view.)

To check the effect of the [**Strong**] setting, magnify the image.

Viewing it as a single image will only display the [**Standard**] effect even if [**Strong**] was set.

-  **Image-recording quality** (p.84)

You can set the pixel count and image quality of the JPEG image to be saved when converting the RAW image. The image size displayed, such as [**8.0M 3456x2304**], has a 3:2 aspect ratio. The pixel count of each aspect ratio is indicated on page 223.

- sRGB **Color space** (p.110)

You can select either sRGB or Adobe RGB. Since the camera's LCD monitor is not compatible with Adobe RGB, the image will not look very different when either color space is set.

- OFF **Peripheral illumination correction** (p.102)



You can set [**Enable**] or [**Disable**]. If [**Enable**] is set, the corrected image will be displayed. If the effect is difficult to discern, press the <⊕> button to magnify the image and look at the image corners. (Press the <⊞⊕> button to return to the normal view.)

- OFF **Distortion correction**

When [**Enable**] is set, image distortion caused by the lens is corrected. If [**Enable**] is set, the distortion-corrected image will be displayed. The correction will have the image periphery to be cropped. Therefore, the image will look slightly larger (It is not a magnified image). With Digital Photo Professional (provided software), you can correct the image distortion while minimizing the trimming of the image periphery.

Since the image resolution may look slightly lower, use the Picture Style's Sharpness setting to make adjustments as necessary.

● OFF **Chromatic aberration correction**

When **[Enable]** is set, lateral chromatic aberration caused by the lens is corrected. If **[Enable]** is set, the corrected image will be displayed. (The image periphery will also be slightly cropped.) If the effect is difficult to discern, press the <  > button to magnify the image. (Press the <   > button to return to the normal view.) The chromatic aberration correction done with the camera will be less pronounced than with Digital Photo Professional (provided software). Therefore the correction might not be so noticeable. In such a case, use Digital Photo Professional to correct the chromatic aberration. Chromatic aberration refers to the inaccurate convergence of colors along the fringes of a subject.

-  The result of RAW image processed in the camera and RAW image processed with Digital Photo Professional does not match exactly.
- Even if image verification data (p.260) is appended to the RAW image, the image verification data is not appended to the JPEG image after processing.

About peripheral illumination correction, distortion correction, and chromatic aberration correction

To execute peripheral illumination correction, distortion correction, and chromatic aberration correction with the camera, the data of the lens used for the shot must be registered in the camera. If the lens data has not been registered in the camera, use EOS Utility (provided software) to register the lens data.

11

Sensor Cleaning

The camera has a Self Cleaning Sensor Unit attached to the image sensor's front layer (low-pass filter) to shake off dust automatically.

The Dust Delete Data can also be appended to the image so that the dust spots remaining can be erased automatically by Digital Photo Professional (provided software).

About smudges adhering to the front of the sensor

Besides dust entering the camera from outside, in rare cases lubricant from the camera's internal parts may adhere to the front of the sensor. In case visible spots still remain after the automatic sensor cleaning, having the sensor cleaned by a Canon Service Center is recommended.



Even while the Self Cleaning Sensor Unit is operating, you can press the shutter button halfway to interrupt the cleaning and start shooting immediately.

Automatic Sensor Cleaning

Whenever you set the power switch to <ON> or <OFF>, the Self Cleaning Sensor Unit operates to automatically shake off the dust on the front of the sensor. Normally, you need not pay attention to this operation. However, you can execute the sensor cleaning at anytime as well as disable it.

Cleaning the Sensor Now



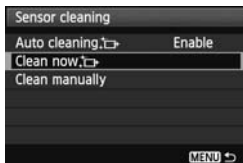

1 Select [Sensor cleaning].

- Under the [] tab, select [**Sensor cleaning**], then press <SET>.



2 Select [Clean now].

- Select [**Clean now **], then press <SET>.
- Select [**OK**] on the dialog screen, then press <SET>.
- ▶ The screen will indicate that the sensor is being cleaned. Although there will be a shutter sound, a picture is not taken.

-  ● For best results, do the sensor cleaning while the camera bottom is placed on a table or other flat surface.
- Even if you repeat the sensor cleaning, the result will not improve that much. Right after the sensor cleaning is finished, the [**Clean now **] option will remain disabled temporarily.

Disabling Automatic Sensor Cleaning

- In step 2, select [**Auto cleaning **] and set it to [**Disable**].
- ▶ The sensor cleaning will no longer be executed when you set the power switch to <ON> or <OFF>.

MENU Appending Dust Delete Data ☆

Normally, the Self Cleaning Sensor Unit will eliminate most of the dust that might be visible on captured images. However, in case visible dust still remains, you can append the Dust Delete Data to the image for erasing the dust spots later. The Dust Delete Data is used by Digital Photo Professional (provided software) to erase the dust spots automatically.

Preparation

- Get a solid-white object (paper, etc.).
- Set the lens focal length to 50mm or longer.
- Set the lens focus mode switch to <MF> and set the focus to infinity (∞). If the lens has no distance scale, look at the front of the lens and turn the focusing ring clockwise all the way.

Obtain the Dust Delete Data



1 Select [Dust Delete Data].

- Under the [Dust Delete Data] tab, select [Dust Delete Data], then press <SET>.

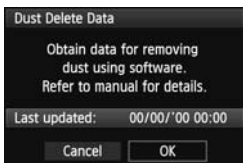

2 Select [OK].

- Select [OK] and press <SET>. After the automatic self-cleaning of the sensor is performed, a message will appear. Although there will be a shutter sound, a picture is not taken.

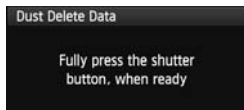
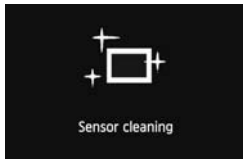

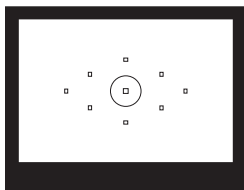

3 Photograph a solid-white object.

- At a distance of 20 cm - 30 cm (0.7 ft. - 1.0 ft.), fill the viewfinder with a patternless, solid-white object and take a picture.
- ▶ The picture will be taken in the aperture-priority AE mode with an aperture of f/22.
- Since the image will not be saved, the data can still be obtained even if there is no card in the camera.
- ▶ When the picture is taken, the camera will start obtaining the Dust Delete Data. When the Dust Delete Data is obtained, a message will appear. Select **[OK]**, and the menu will reappear.
- If the data was not obtained successfully, a message to that effect will appear. Follow the “Preparation” procedure on the preceding page, then select **[OK]**. Take the picture again.



About the Dust Delete Data

After the Dust Delete Data is obtained, it is appended to all the JPEG and RAW images captured thereafter. Before an important shoot, you should update the Dust Delete Data by obtaining it again.

To erase dust spots automatically with the provided software, see the Software Instruction Manual in the CD-ROM.

The Dust Delete Data appended to the image is so small that it hardly affects the image file size.

! Be sure to use a solid-white object such as a new sheet of white paper. If the paper has any pattern or design, it may be recognized as dust data and affect the accuracy of the dust deletion with the software.

MENU Manual Sensor Cleaning ☆

Dust which could not be removed by the automatic sensor cleaning can be removed manually with a blower, etc.

The surface of the image sensor is extremely delicate. If the sensor needs to be cleaned directly, having it done by a Canon Service Center is recommended.

Before cleaning the sensor, detach the lens from the camera.



1 Select [Sensor cleaning].

- Under the [F:] tab, select [**Sensor cleaning**], then press <SET>.

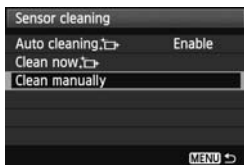

2 Select [Clean manually].

- Select [**Clean manually**], then press <SET>.



3 Select [OK].

- Select [**OK**], then press <SET>.
- ▶ In a moment, the reflex mirror will lockup and the shutter will open.
- “CLn” will blink on the LCD panel.

4 End the cleaning.

- Set the power switch to <OFF>.



- As power source, using the AC Adapter Kit ACK-E6 (sold separately) is recommended.
- If you use a battery, make sure it is fully recharged. If the battery grip with size-AA/LR6 batteries is attached, manual sensor cleaning will not be possible.

- **While cleaning the sensor, never do any of the following. Doing any of the following will cut off the power and close the shutter. The shutter curtains and image sensor might get damaged.**
 - **Setting the power switch to <OFF>.**
 - **Opening the battery compartment cover.**
 - **Opening the card slot cover.**
- The surface of the image sensor is extremely delicate. Clean the sensor with care.
- Use a plain blower without any brush attached. A brush can scratch the sensor.
- Do not insert the blower tip inside the camera beyond the lens mount. If the power is cut off, the shutter will close and the shutter curtains or reflex mirror might get damaged.
- Never use canned air or gas to clean the sensor. The blowing force can damage the sensor or the spray gas can freeze on the sensor.
- If a smudge that cannot be removed with a blower remains, having the sensor cleaned by a Canon Service Center is recommended.

12

Printing Images

- **Printing** (p.236)
You can connect the camera directly to a printer and print out the images in the card. The camera is compatible with “PictBridge” which is the standard for direct printing.
- **Digital Print Order Format (DPOF)** (p.245)
DPOF (Digital Print Order Format) enables you to print images recorded in the card according to your printing instructions such as the image selection, quantity to print, etc. You can print multiple images in one batch or give the print order to a photofinisher.

Preparing to Print

The direct printing procedure is done entirely with the camera while you look at the LCD monitor.

Connecting the Camera to a Printer

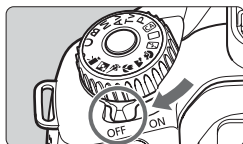

- 1 Set the camera's power switch to <OFF>.

- 2 Set up the printer.

- For details, see the printer's instruction manual.

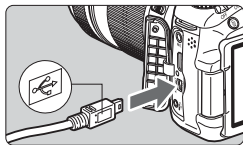

- 3 Connecting the camera to the printer.

- Use the interface cable provided with the camera.
- Connect the cable to the camera's <DIGITAL> terminal with the cable plug's <↔> icon facing the back of the camera.
- To connect to the printer, refer to the printer's instruction manual.

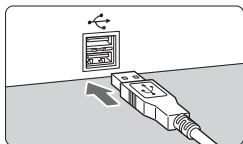

- 4 Turn on the printer.

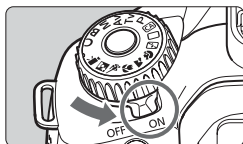

- 5 Set the camera's power switch to <ON>.

- ▶ Some printers may make a beeping sound.

PictBridge



6 Playback the image.

- Press the <▶> button.
- ▶ The image will appear, and the <📷> icon will appear on the upper left to indicate that the camera is connected to a printer.



- Movies cannot be printed.
- The camera cannot be used with printers compatible only with CP Direct or Bubble Jet Direct.
- Do not use any interface cable other than the one provided.
- If there is a long beeping sound in step 5, it indicates a problem with the printer. Resolve the problem displayed by the error message (p.244).



- You can also print RAW images taken with this camera. For printing in A4 or Letter and larger paper sizes, using a JPEG **L** image processed from RAW (except **M RAW** and **S RAW**) is recommended.
- If you use a battery pack to power the camera, make sure it is fully charged. With a fully-charged battery, printing up to approx. 4 hours is possible.
- Before disconnecting the cable, first turn off the camera and printer. Hold the plug (not the cord) to pull out the cable.
- For direct printing, using the AC Adapter Kit ACK-E6 (sold separately) to power the camera is recommended.

Printing

The screen display and setting options will differ depending on the printer. Some settings might not be available. For details, see the printer's instruction manual.

Printer-connected icon



1 Select the image to be printed.

- Check that the icon is displayed on the upper left of the LCD monitor.
- Turn the dial to select the image to be printed.

2 Press .

- ▶ The print setting screen will appear.

Print setting screen

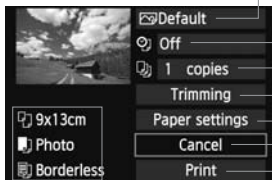

Sets the printing effects (p.240).

Sets the date or file number imprinting to on or off.

Sets the quantity to be printed.

Sets the trimming (cropping) (p.243).

Sets the paper size, type, and layout.

Returns to the screen in step 1.

Starts the printing.

The paper size, type, and layout you have set are displayed.

* Depending on the printer, certain settings such as the date and file number imprinting and trimming might not be available.

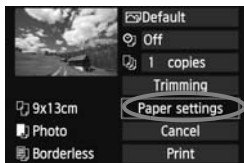

3 Select [Paper settings].

- Select [Paper settings], then press .
- ▶ The paper settings screen will appear.

Setting the Paper Size



- Select the size of the paper loaded in the printer, then press **<SET>**.
- ▶ The paper type screen will appear.

Setting the Paper Type



- Select the type of the paper loaded in the printer, then press **<SET>**.
- ▶ The page layout screen will appear.

Setting the Page Layout



- Select the page layout, then press **<SET>**.
- ▶ The print setting screen will reappear.

Bordered	The print will have white borders along the edges.
Borderless	The print will have no borders. If your printer cannot print borderless prints, the print will have borders.
Bordered 	The shooting information* will be imprinted on the border on 9x13cm and larger prints.
xx-up	Option to print 2, 4, 8, 9, 16, or 20 images on one sheet.
20-up 35-up 	On A4 or Letter size paper, 20 or 35 thumbnails of the images ordered through DPOF (p.245) will be printed. • [20-up] will have the shooting information* imprinted.
Default	The page layout will vary depending on the printer model or its settings.

* From the Exif data, the camera name, lens name, shooting mode, shutter speed, aperture, exposure compensation amount, ISO speed, white balance, etc., will be imprinted.

If the image's aspect ratio is different from the printing paper's aspect ratio, the image may be cropped significantly if you print it as a borderless print. If the image is cropped, it may look more grainy on the paper due to the fewer number of pixels.

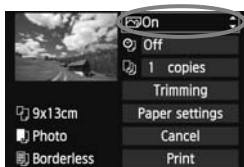

4 Set the printing effects.

- Set as necessary. If you need not set any printing effects, go to step 5.
- **What is displayed on the screen differs depending on the printer.**
- Select the option on the upper right (circled in the screenshot), then press **<SET>**.
- Select the desired printing effect, then press **<SET>**.
- If the **<INFO>** icon is displayed next to **<INFO>**, you can also adjust the printing effect (p.242).

Printing Effect	Description
On	The image will be printed according to the printer's standard colors. The image's Exif data is used to make automatic corrections.
Off	No automatic correction will be applied.
VIVID	The image will be printed with higher saturation to produce more vivid blues and greens.
NR	Image noise is reduced before printing.
B/W B/W	Prints in black-and-white with true blacks.
B/W Cool tone	Prints in black-and-white with cool, bluish blacks.
B/W Warm tone	Prints in black-and-white with warm, yellowish blacks.
Natural	Prints the image in the actual colors and contrast. No automatic color adjustments are applied.
Natural M	The printing characteristics are the same as the "Natural" setting. However, this setting enables finer printing adjustments than with "Natural."
Default	The printing will differ depending on the printer. For details, see the printer's instruction manual.

* When you change the printing effects, it is reflected in the image displayed on the upper left. Note that the printed image might look slightly different from the displayed image which is only an approximation. This also applies to [Brightness] and [Adjust levels] on page 242.

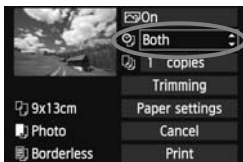

5 Set the date and file number imprinting.

- Set as necessary.
- Select <📅>, then press <ⓈET>.
- Set as desired, then press <ⓈET>.

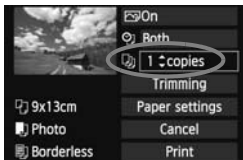

6 Set the number of copies.

- Set as necessary.
- Select <📄>, then press <ⓈET>.
- Set the number of copies, then press <ⓈET>.

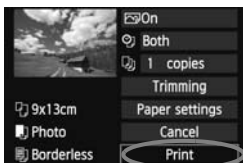

7 Start printing.

- Select [Print], then press <ⓈET>.



- With Easy printing, you can print another image using the same settings. Just select the image and press the <📄> button. With Easy printing, the number of copies will always be 1. (You cannot set the number of copies.) Also, any trimming (p.243) will not be applied.
- The **[Default]** setting for printing effects and other options are the printer's own default settings as set by the printer's manufacturer. See the printer's instruction manual to find out what the **[Default]** settings are.
- Depending on the image's file size and image-recording quality, it may take some time for the printing to start after you select **[Print]**.
- If image tilt correction (p.243) has been applied, it may take longer to print the image.
- To stop the printing, press <ⓈET> while **[Stop]** is displayed, then select **[OK]**.
- If you execute **[Clear all camera settings]** (p.51), all the settings will revert to the default.

Adjustment of Printing Effects



In step 4 on page 240, select the printing effect. When the  icon is displayed brightly next to **<INFO.>**, press the **<INFO.>** button. You can then adjust the printing effect. What can be adjusted or what is displayed will depend on the selection made in step 4.

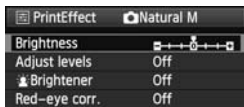

● Brightness

The image brightness can be adjusted.

● Adjust levels

When you select **[Manual]**, you can change the histogram's distribution and adjust the image's brightness and contrast.

With the Adjust levels screen displayed, press the **<INFO.>** button to change the position of the . Press the **<◀▶>** key to freely adjust the shadow level (0 - 127) or highlight level (128 - 255).





● Brightener

Effective in backlit conditions which can make the subject's face look dark. When **[On]** is set, the face will be brightened for printing.

● Red-eye corr.

Effective in flash images where the subject has red eye. When **[On]** is set, the red eye will be corrected for printing.

- The [ **Brightener**] and [**Red-eye corr.**] effects will not show on the screen.
- When you select **[Detail set.]**, you can adjust the **[Contrast]**, **[Saturation]**, **[Color tone]**, and **[Color balance]**. To adjust the **[Color balance]**, use . B is for blue, A is amber, M is magenta, and G is green. The color in the respective direction will be corrected.
- If you select **[Clear all]**, all the printing effect settings will be reverted to the default.

Trimming the Image



You can crop the image and print only the trimmed portion as if the image was recomposed. **Do the trimming right before printing.** If you set the trimming and then set the print settings, you may have to set the trimming again.

1 On the print setting screen, select [Trimming].

2 Set the trimming frame size, position, and aspect ratio.

- The image area within the trimming frame will be printed. The trimming frame's aspect ratio can be changed with **[Paper settings]**.

Changing the trimming frame size

When you press the $\langle \text{Q} \rangle$ or $\langle \text{Q} \cdot \text{Q} \rangle$ button, the size of the trimming frame will change. The smaller the trimming frame, the larger the image magnification will be for printing.

Moving the trimming frame

Use $\langle \text{Q} \cdot \text{Q} \rangle$ to move the frame over the image vertically or horizontally. Move the trimming frame until it covers the desired image area.

Rotating the frame

Each time you press the $\langle \text{INFO} \rangle$ button, the trimming frame will switch between the vertical and horizontal orientations. This enables you to create a vertical-oriented print from a horizontal image.

Image tilt correction

By turning the $\langle \text{Q} \cdot \text{Q} \rangle$ dial, you can adjust the image tilt angle up to ± 10 degrees in 0.5-degree increments. When you adjust the image tilt, the $\langle \text{Q} \cdot \text{Q} \rangle$ icon on the screen will turn blue.

3 Press $\langle \text{SET} \rangle$ to exit the trimming.

- ▶ The print setting screen will reappear.
- You can check the trimmed image area on the upper left of the print setting screen.

- Depending on the printer, the trimmed image area might not be printed as you specified.
- The smaller you make the trimming frame, the grainier the picture will look in the print.
- While trimming the image, look at the camera's LCD monitor. If you look at the image on a TV screen, the trimming frame might not be displayed accurately.



Handling Printer Errors

If you resolve a printer error (no ink, no paper, etc.) and select **[Continue]** to resume printing but it does not resume, operate the buttons on the printer to resume printing. For details on resuming the printing, see the printer's instruction manual.

Error Messages

If a problem occurs during printing, an error message will appear on the camera's LCD monitor. Press **<SET>** to stop printing. After fixing the problem, resume printing. For details on how to fix a printing problem, refer to the printer's instruction manual.

Paper Error

Check whether the paper is properly loaded in the printer.

Ink Error

Check the printer's ink level, and check the waste ink tank.

Hardware Error

Check for any printer problems other than paper and ink problems.

File Error

The selected image cannot be printed via PictBridge. Images taken with a different camera or images edited with a computer might not be printable.

Digital Print Order Format (DPOF)

You can set the print type, date imprinting, and file No. imprinting. The print settings will be applied to all print-ordered images. (They cannot be set individually for each image.)

Setting the Printing Options



1 Select [Print order].

- Under the [Print order] tab, select [Print order], then press <SET>.

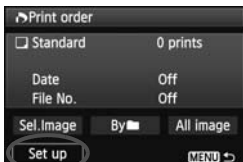

2 Select [Set up].

- Select [Set up], then press <SET>.

3 Set the option as desired.

- Set the [Print type], [Date], and [File No.].
- Select the option to be set, then press <SET>. Select the desired setting, then press <SET>.

[Print type]

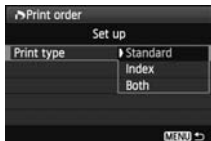

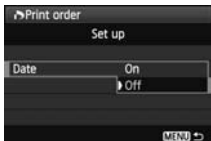

[Date]





[File No.]



Print type	 Standard	Prints one image on one sheet.
	 Index	Multiple thumbnail images are printed on one sheet.
	 Both	Prints both the standard and index prints.
Date	On	[On] imprints the recorded date on the print.
	Off	
File number	On	[On] imprints the file No. on the print.
	Off	

4 Exit the setting.

- Press the <MENU> button.
- ▶ The print order screen will reappear.
- Next, select [**Sel.Image**], [**By** ], or [**All image**] to order the images to be printed.

- 
- Even if [**Date**] and [**File No.**] are set to [**On**], the date or file No. might not be imprinted depending on the print type setting and printer model.
 - When printing with DPOF, you must use the card whose print order specifications have been set. It will not work if you just extract images from the card and try to print them.
 - Certain DPOF-compatible printers and photofinishers might not be able to print the images as you specified. If this happens with your printer, refer to the printer's instruction manual. Or check with your photofinisher about compatibility when ordering prints.
 - Do not insert into the camera a card whose print order was set by a different camera and then try to specify a print order. The print order may not work or may be overwritten. Also, depending on the image type, the print order may not be possible.

- 
- RAW images and movies cannot be print ordered.
 - With [**Index**] prints, both the [**Date**] and [**File No.**] cannot be set to [**On**] at the same time.

Print Ordering

● Sel.Image



Select and order images one by one. To display the three-image display, press the < [Grid Icon] [Magnifying Glass Icon] > button. To return to the single-image display, press the < [Magnifying Glass Icon] > button.

After completing the print order, press the < MENU > button to save the print order to the card.



[Standard] [Both]

Press the < ▲▼ > key to set the number of copies to be printed for the displayed image.



[Index]

Press the < ▲▼ > key to checkmark the box < [Checkmark Icon] > and the image will be included in the index print.

● By [Folder Icon]

Select [**Mark all in folder**] and select the folder. A print order for one copy of all the images in the folder will be placed. If you select [**Clear all in folder**] and select the folder, the print order for that folder will all be canceled.

● All image

If you select [**Mark all on card**], one copy of all the images in the card will be set for printing. If you select [**Clear all on card**], the print order will be cleared for all the images in the card.



- Note that RAW images and movies will not be included in the print order even if you set "By [Folder Icon]" or "All image."
- When using a PictBridge printer, print no more than 400 images for one print order. If you specify more than this, all the images might not be printed.

Direct Printing with DPOF



With a PictBridge printer, you can easily print images with DPOF.

1 Prepare to print.

- See page 236. Follow the “Connecting the Camera to a Printer” procedure up to step 5.

2 Under the [] tab, select [Print order].

3 Select [Print].

- [Print] will be displayed only if the camera is connected to the printer and printing is possible.

4 Set the [Paper settings] (p.238).

- Set the printing effects (p.240) if necessary.

5 Select [OK].

- Before printing, be sure to set the paper size.
- Certain printers cannot imprint the file No.
- If **[Bordered]** is set, certain printers might imprint the date on the border.
- Depending on the printer, the date might look light if it is imprinted on a bright background or on the border.

- Under **[Adjust levels]**, **[Manual]** cannot be selected.
- If you stopped the printing and want to resume printing the remaining images, select **[Resume]**. Note that printing will not resume if you stop the printing and any of the following occurs:
 - Before resuming the printing, you changed the print order or deleted print-ordered images.
 - When you set the index, you changed the paper setting before resuming the printing.
 - When you paused the printing, the card's remaining capacity was low.
- If a problem occurs during printing, see page 244.

MENU Setting Custom Functions ☆

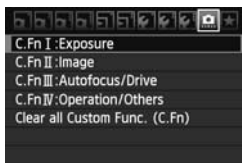

1 Select [].

2 Select the group.

- Select a Custom Function group (I to IV), then press <SET>.

Custom Function No.

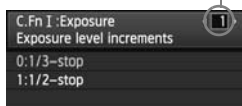

3 Select the Custom Function No.

- Press the <◀▶> key to select the number of the Custom Function to be set, then press <SET>.

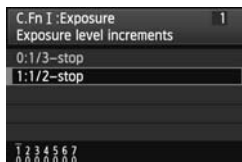

4 Change the setting as desired.

- Select the desired setting (number), then press <SET>.
- Repeat steps 2 to 4 if you want to set other Custom Functions.
- At the bottom of the screen, the current Custom Function settings are indicated below the respective function numbers.

5 Exit the setting.

- Press the <MENU> button.
- ▶ The screen in step 2 will reappear.

Clearing All Custom Functions

In step 2, select [**Clear all Custom Func. (C.Fn)**] to clear all the Custom Function settings.

Even if all the Custom Functions are cleared, the setting for [**C.Fn IV -4: Focusing Screen**] will remain unchanged.

MENU Custom Functions [☆]

C.Fn I: Exposure

			 LV shooting
1	Exposure level increments	p.252	<input type="radio"/>
2	ISO speed setting increments		<input type="radio"/>
3	ISO expansion		<input type="radio"/>
4	Bracketing auto cancel	p.253	<input type="radio"/>
5	Bracketing sequence		<input type="radio"/>
6	Safety shift		<input type="radio"/>
7	Flash sync. speed in Av mode		<input type="radio"/>

C.Fn II: Image

1	Long exposure noise reduction	p.254	<input type="radio"/>
2	High ISO speed noise reduction		<input type="radio"/>
3	Highlight tone priority	p.255	<input type="radio"/>

C.Fn III: Autofocus/Drive

1	Lens drive when AF impossible	p.255	<input type="radio"/> (AF-Quick)
2	AF point selection method		
3	Superimposed display	p.256	
4	AF-assist beam firing		<input type="radio"/> (AF-Quick)
5	Mirror lockup	p.257	

C.Fn IV: Operation/Others

1	AF and metering buttons	p.257	<input type="radio"/>
2	Assign SET button	p.258	<input type="radio"/> (Except 5)
3	Dial direction during Tv/Av		<input type="radio"/>
4	Focusing Screen	p.259	
5	Add image verification data	p.260	<input type="radio"/>



- The shaded Custom Functions do not take effect during Live View (LV) shooting. (Settings are disabled.)
- Custom Functions do not apply to movie shooting.

MENU Custom Function Settings ☆

C.Fn I: Exposure

C.Fn I -1 Exposure level increments

0: 1/3-stop

1: 1/2-stop

Sets 1/2-stop increments for the shutter speed, aperture, exposure compensation, AEB, flash exposure compensation, etc. Effective when you prefer to control the exposure in less fine increments than 1/3-stop increments.

 With setting 1, the exposure level will be displayed in the viewfinder and on the LCD panel as shown below.



C.Fn I -2 ISO speed setting increments

0: 1/3-stop

1: 1-stop

C.Fn I -3 ISO expansion

0: Off

1: On

For the ISO speed, "H" (equivalent to ISO 12800) will be selectable. Note that if [ C.Fn II -3: Highlight tone priority] is set to [1: Enable], "H" (equivalent to ISO 12800) cannot be set.

C.Fn I -4 Bracketing auto cancel

0: On

The AEB and WB-BKT settings will be canceled if you set the power switch to <OFF> or clear the camera settings. AEB will also be canceled when the flash is ready to fire or if you switch to the movie mode.

1: Off

The AEB and WB-BKT settings will not be canceled even if you set the power switch to <OFF>. (If the flash is ready to fire, AEB will be canceled temporarily, but the AEB amount will be retained.)

C.Fn I -5 Bracketing sequence

The AEB shooting sequence and white balance bracketing sequence can be changed.

0: 0, -, +

1: -, 0, +

AEB	WB Bracketing	
	B/A Direction	M/G Direction
0 : Standard exposure	0 : Standard white balance	0 : Standard white balance
- : Decreased exposure	- : Blue bias	- : Magenta bias
+ : Increased exposure	+ : Amber bias	+ : Green bias

C.Fn I -6 Safety shift

0: Disable

1: Enable (Tv/Av)

This takes effect in the shutter-priority AE (**Tv**) and aperture-priority AE (**Av**) modes. When the subject's brightness changes erratically and the standard auto exposure cannot be obtained, the camera will change the exposure setting automatically to obtain a standard exposure.

C.Fn I -7 Flash sync. speed in Av mode

0: Auto

Normally, the sync speed will be set automatically within 1/250 sec. to 30 sec. to suit the subject brightness. High-speed sync can also take effect.

1: 1/250-1/60 sec. auto

When flash is used with aperture-priority AE (**Av**), this prevents a slow flash-sync speed from being set automatically in low-light conditions. It is effective for preventing subject blur and camera shake. However, while the subject will be properly exposed with the flash, the background will come out dark.

2: 1/250 sec. (fixed)

The flash-sync speed is fixed to 1/250 sec. This more effectively prevents subject blur and camera shake than with setting 1. However, the background may come out darker than with setting 1.

C.Fn II: Image

C.Fn II -1 Long exposure noise reduction

0: Off

1: Auto

For 1 sec. or longer exposures, noise reduction is performed automatically if noise typical of long exposures is detected. This **[Auto]** setting is effective in most cases.

2: On

Noise reduction is performed for all exposures of 1 sec. or longer. The **[On]** setting may be able to reduce noise which otherwise cannot be detected with the **[Auto]** setting.

- With settings 1 and 2, after the picture is taken, the noise reduction process may take the same amount of time as the exposure. You cannot take another picture until the noise reduction process is completed.
- At ISO 1600 and higher, noise might be more pronounced with setting 2 than with setting 0 or 1.
- With setting 2, if a long exposure is shot with the Live View displayed, "BUSY" will be displayed during the noise reduction process. The Live View display will not appear until the noise reduction is completed. (You cannot take another picture.)

C.Fn II -2 High ISO speed noise reduction

Reduces the noise generated in the image. Although noise reduction is applied at all ISO speeds, it is particularly effective at high ISO speeds. At low ISO speeds, the noise in the shadow areas is further reduced. Change the setting to suit the noise level.

0: Standard

2: Strong

1: Low

3: Disable

- With setting 2, the maximum burst for continuous shooting will greatly decrease.
- If you playback a RAW or RAW+JPEG image with the camera or print an image directly, the effect of the high ISO speed noise reduction may look minimal. You can check the noise reduction effect or print noise-reduced images with Digital Photo Professional (provided software).

C.Fn II -3 Highlight tone priority

0: Disable

1: Enable

Improves the highlight detail. The dynamic range is expanded from the standard 18% gray to bright highlights. The gradation between the grays and highlights becomes smoother.



- With setting 1, the Auto Lighting Optimizer (p.101) is automatically set to **[Disable]** and the setting cannot be changed.
- With setting 1, noise may become slightly more pronounced than usual.



With setting 1, the settable range will be ISO 200 - 6400. Also, the <D+> icon will be displayed on the LCD panel and in the viewfinder when highlight tone priority is enabled.

C.Fn III: Autofocus/Drive

C.Fn III -1 Lens drive when AF impossible

If autofocus is executed, but focus cannot be achieved, the camera can either keep trying to focus or stop.



0: Continue focus search



1: Stop focus search



Prevents the camera from becoming grossly out of focus as it attempts to focus again. Especially convenient with super telephoto lenses which can become extremely out of focus.

C.Fn III -2 AF point selection method

0:  Activate AF selection /  Select AF point

You can press the < > button, then select the AF point directly with < >.

1:  Auto selection /  Manual selection

Pressing the < > button will set automatic AF point selection. To select the AF point manually, you can use < > without first pressing the < > button.



With setting 1, the C.Fn IV -2 [**Assign SET button**] setting will be disabled.

C.Fn III -3 Superimposed display

0: On

1: Off

When focus is achieved, the AF point will not light up in red in the viewfinder. Set this if the AF points lighting up is too distracting. The AF point will still light up when you select it.

C.Fn III -4 AF-assist beam firing

The AF-assist beam can be emitted by the camera's built-in flash or by an external, EOS-dedicated Speedlite.

0: Enable

1: Disable

The AF-assist beam is not emitted.

2: Enable external flash only

If an external, EOS-dedicated Speedlite is attached, it will emit the AF-assist beam when necessary. The camera's built-in flash will not fire the AF-assist beam.

3: IR AF assist beam only

Among EOS-dedicated Speedlites, only those which have an infrared AF-assist beam will be able to emit the beam. This prevents any Speedlite which uses a series of small flashes (like the built-in flash) from firing the AF-assist beam.

 If the external, EOS-dedicated Speedlite's **[AF-assist beam firing]** Custom Function is set to **[Disabled]**, the Speedlite will not emit the AF-assist beam even if the camera's C.Fn III -4-0/2/3 is set.

C.Fn III -5 Mirror lockup

0: Disable

1: Enable

Prevents camera vibrations caused by the reflex mirror action that can disturb shooting with super telephoto lenses or close-up (macro) shooting. See page 125 for the mirror lockup procedure.

C.Fn IV: Operation/Others

Customizing camera controls with the Quick Control screen (p.45)

The Custom Controls function on the Quick Control screen is the same as the Custom Functions below:

[AF and metering buttons] : C.Fn IV -1

[AF point selection method] : C.Fn III -2

[Assign SET button] : C.Fn IV -2



C.Fn IV -1 AF and metering buttons

You can change the function assigned to the halfway pressing of the shutter button, the AF start button, and the AE lock button. You can assign the following functions to the buttons in one of ten combinations: Metering & AF start, AE lock, metering start, AF stop, and no function.

C.Fn IV -2 Assign SET button

You can assign a frequently-used function to <SET>. Press <SET> when the camera is shooting-ready.

0: Default (no func)

1: Image quality

Pressing <SET> will display the image-recording quality setting screen on the LCD monitor. Select the desired image-recording quality, then press <SET>.

2: Picture Style

Pressing <SET> will display the Picture Style selection screen on the LCD monitor. Select a Picture Style, then press <SET>.

3: White balance

Pressing <SET> will display the white balance selection screen on the LCD monitor. Select the desired white balance, then press <SET>.

4: Flash exp. comp.

Pressing <SET> will display the flash exposure compensation setting screen on the LCD monitor. Set the flash exposure compensation, then press <SET>.

5: Viewfinder

Pressing <SET> will display the electronic level (using the exposure level scale) in the viewfinder.





 If C.Fn III -2-1 (AF point selection method) is set, the [Assign SET button] setting will be disabled.

C.Fn IV -3 Dial direction during Tv/Av

0: Normal

1: Reverse direction

The dial's turning direction for setting the shutter speed and aperture can be reversed.

In the manual exposure mode, the direction of the < > and < > dials will be reversed. In other shooting modes, the < > dial will be reversed. The < > dial's turning direction will be the same for the manual exposure mode and exposure compensation.

C.Fn IV -4 Focusing Screen

If you change the focusing screen, change this setting to match the focusing screen type. This is to obtain the standard exposure.

0: Ef-A

1: Ef-D

2: Ef-S

About focusing screen characteristics

Ef-A: Standard Precision Matte

Standard focusing screen which comes with the camera. It provides a good balance between viewfinder brightness and manual focusing ease.

Ef-D: Precision Matte with Grid

Grid lines are added to the Ef-A focusing screen. The grid helps to align the shot vertically and horizontally.

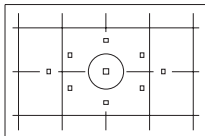

Ef-S: Super Precision Matte

The point of focus is easier to distinguish than with the Ef-A focusing screen. Helpful to users who often focus manually.



About Super Precision Matte Ef-S and Maximum Lens Aperture

- This focusing screen is optimized for f/2.8 and faster lenses.
- With lenses slower than f/2.8, the viewfinder will look darker than with the Ef-A focusing screen.



- Even if you clear all the Custom Function settings to the default settings, the C.Fn IV -4 setting will be retained.
- Since the EOS 60D's standard focusing screen is the Ef-A, C.Fn IV -4-0 is set upon factory shipment.
- To change the focusing screen, refer to the instructions that come with the focusing screen. If the focusing screen does not come down with the holder, tilt the camera forward.
- The C.Fn IV -4 will not be included in the Camera user setting registered (p.262).

C.Fn IV -5 Add image verification data

0: Disable

1: Enable

Data for verifying whether the image is original or not is appended to the image automatically. When the shooting information of an image appended with the verification data is displayed (p.191), the <🔒> icon will appear.

To verify whether the image is original, the Original Data Security Kit OSK-E3 (sold separately) is required.

 The images are not compatible with the image encryption/decryption features of Original Data Security Kit OSK-E3.

MENU Registering My Menu ☆

Under the My Menu tab, you can register up to six menu options and Custom Functions whose settings you change frequently.

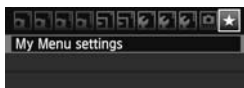

1 Select [My Menu settings].

- Under the [★] tab, select [My Menu settings], then press <SET>.

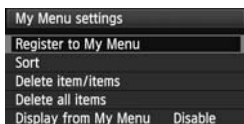

2 Select [Register to My Menu].

- Select [Register to My Menu], then press <SET>.

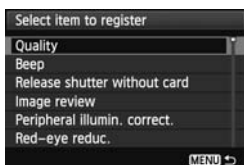

3 Register the desired items.

- Select the item to be registered, then press <SET>.
- On the confirmation dialog, select [OK] and press <SET> to register the item.
- You can register up to six items.
- To return to the screen in step 2, press the <MENU> button.

About My Menu settings

● Sort

You can change the order of the registered items in My Menu. Select [Sort] and select the item whose order you want to change. Then press <SET>. With [◆] displayed, press the <▲▼> key to change the order, then press <SET>.

● Delete item/items and Delete all items

You can delete any of the registered items. [Delete item/items] deletes one item at a time, and [Delete all items] deletes all items.

● Display from My Menu

When [Enable] is set, the [★] tab will be displayed first when you display the menu screen.

C: Register Camera User Settings ☆

Under the Mode Dial's <C> position, you can register most of the current camera settings including your preferred shooting mode, menus, Custom Function settings, etc.

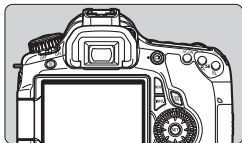

1 Set the camera.

- First set the functions you want to register: Shooting mode, shutter speed, aperture, ISO speed, AF mode, AF point, metering mode, drive mode, exposure compensation, and flash exposure compensation.
- When setting the menu functions, refer to the next page.



2 Select [Camera user settings].

- Under the [P:] tab, select [Camera user settings], then press <SET>.



3 Select [Register settings].

- Select [Register settings], then press <SET>.













4 Select [OK].

- On the confirmation dialog, select [OK] and press <SET>.
- ▶ The current camera settings will be registered under the Mode Dial's <C> position.



Clearing the Camera User Settings

In step 3, if you select [Clear settings], the setting of the Mode Dial's C position will revert to the default setting.

Menu Options which can be Registered

- [] Quality, Beep, Release shutter without card, Image review, Peripheral illumination correction, Red-eye reduction, Flash control (Flash firing, Shutter sync., Flash exposure compensation, E-TTL II metering, Wireless function)
- [] Exposure compensation/AEB, Auto Lighting Optimizer, Picture Style, White balance, Custom White Balance, WB Shift/BKT, Color space
- [] ISO Auto
- [] Live View shooting, AF mode, Grid display, Aspect ratio, Exposure simulation, Silent shooting, Metering timer
- [] Highlight alert, AF point display, Histogram, Image jump w/ , Slide show
- [] Auto power off, Auto rotate, File numbering
- [] LCD brightness, Sensor cleaning (Auto cleaning), Lock 
- [] INFO. button display options
- [] Custom Functions



- My Menu settings will not be registered.
- When the Mode Dial is set to <C>, the [ **Clear all camera settings**] and [ **Clear all Custom Func. (C.Fn)**] menu options will be disabled.



- When the Mode Dial is set to <C>, you can still change the camera settings such as the drive mode and menu options, but the changes will not be registered. If you want to register those changes to the Mode Dial's C position, follow the registration procedure on the preceding page.
- By pressing the <INFO.> button, you can check which shooting mode is registered under <C> (p.266).



14

Reference

This chapter provides reference information for camera features, system accessories, etc.

INFO. Button Functions



When you press the <INFO.> button while the camera is ready to shoot, you can display [**Displays camera settings**], [**Displays shooting functions**] (p.267), and [**Electronic level**] (p.127).



Under the [**INFO. button display options**] option enables you to select what the <INFO.> button is to display when pressed.

- Select the desired display option and press <SET> to append a checkmark <✓>.
- After making the selection, select [**OK**], then press <SET>. Note that you cannot remove the checkmark <✓> for all three display options.

- The [**Displays camera settings**] sample screen is displayed in English for all languages.
- Even if you uncheck the [**Electronic level**] so it does not appear, it will still appear for Live View shooting and movie shooting.

Camera Settings

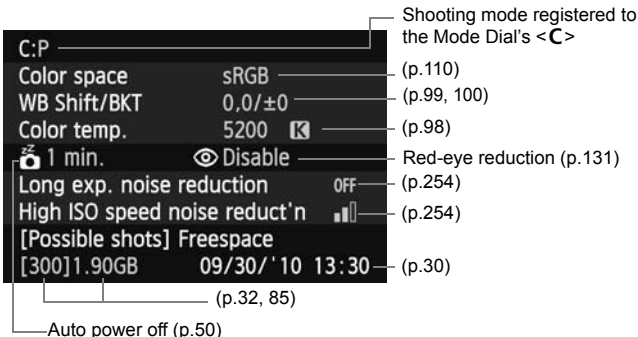

Shooting Settings

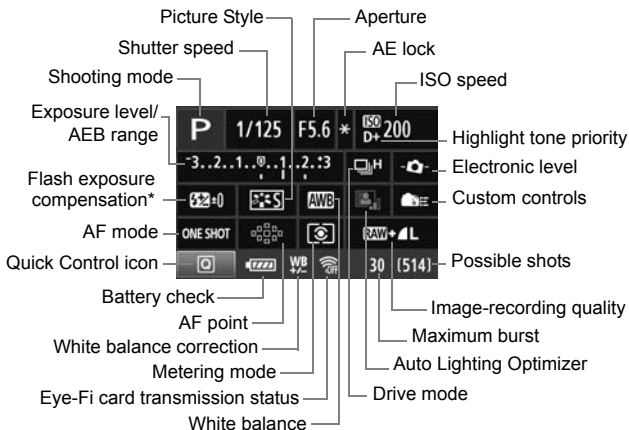

* If flash exposure compensation is set with an external Speedlite, the flash exposure compensation icon will change from to .

- When you press the $\langle \text{Q} \rangle$ button, the Quick Control screen appears (p.44).
- If you press the $\langle \text{AF} \rangle$, $\langle \text{DRIVE} \rangle$, $\langle \text{ISO} \rangle$, $\langle \text{AF point} \rangle$, or $\langle \text{INFO} \rangle$ button, the respective setting screen will appear on the LCD monitor and you can turn the $\langle \text{dial} \rangle$ or $\langle \text{dial} \rangle$ to set the function. You can also select the AF point with $\langle \text{AF point} \rangle$.

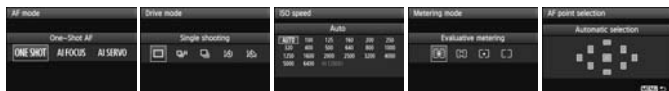

If you turn off the power while the “Shooting settings display” screen is displayed, the same screen will be displayed when you turn on the power again. To avoid this, press the $\langle \text{INFO} \rangle$ button to turn off the display on the LCD monitor, then turn off the power switch.

MENU Checking the Battery Information

You can check the battery's condition on the LCD monitor. Each Battery Pack LP-E6 has a unique serial No., and you can register multiple battery packs to the camera. When you use this feature, you can check the registered battery pack's remaining capacity and operation history.



Select [Battery info.].

- Under the [Y:] tab, select [Battery info.], then press <SET>.
- ▶ The battery info screen will appear.

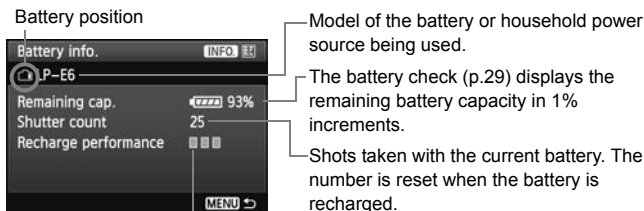

Battery's recharge performance level is displayed in one of three levels.

- (Green): Battery's recharge performance is fine.
- (Green): Battery's recharge performance is slightly degraded.
- (Red) : Purchasing a new battery is recommended.

⚠ Do not use any battery other than the Battery Pack LP-E6. Otherwise, the camera's full performance may not be attained or malfunction may result.

- The battery information will be displayed even when the LP-E6 battery pack is in the Battery Grip BG-E9.
- When size-AA/LR6 batteries are used in the Battery Grip BG-E9, only the battery check will be displayed.
- If for some reason, communication with the battery is not successful, the battery check display will show <□□> on the LCD panel and in the viewfinder. [Cannot communicate with battery] will be displayed. Just select [OK] and you can continue shooting.

Registering the Battery to the Camera

You can register up to six Battery Packs LP-E6 to the camera. To register multiple battery packs to the camera, do the procedure below for each battery pack.

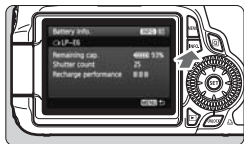

1 Press the <INFO.> button.

- With the battery info. screen displayed, press the <INFO.> button.
- ▶ The battery history screen will appear.
- ▶ If the battery has not been registered, it will be grayed out.

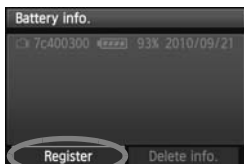

2 Select [Register].

- Select [Register], then press <SET>.
- ▶ The confirmation dialog will appear.



3 Select [OK].

- Select [OK], then press <SET>.
- ▶ The battery pack will be registered, and the battery history screen will reappear.
- ▶ The grayed-out battery number will now be displayed in white letters.
- Press the <MENU> button. The battery info. screen will reappear.



- Battery registration is not possible if size-AA/LR6 batteries are in the Battery Grip BG-E9 or if you use the AC Adapter Kit ACK-E6.
- If six battery packs have already been registered, [Register] cannot be selected. To delete unnecessary battery information, refer to page 271.

Labeling the Serial No. on the Battery

Affixing a serial No. label onto all the registered Battery Pack LP-E6's makes it convenient.

Serial No.

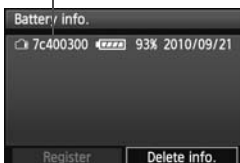

1 Write the serial No. on a label.

- Write the serial No. displayed on the battery history screen on a label approx. 25 mm x 15 mm / 1.0 in. x 0.6 in. in size.

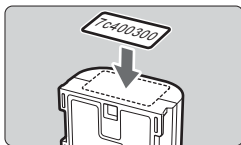

2 Take out the battery and affix the label.

- Set the power switch to <OFF>.
- Open the battery compartment cover and remove the battery.
- Affix the label as shown (side with no electrical contacts) in the illustration.
- Repeat this procedure for all of your battery packs so you can easily see the serial No.

- Do not affix the label on any part other than as shown in the illustration in step 2. Otherwise, the misplaced label might make it difficult to insert the battery or impossible to turn on the camera.
- If you use Battery Grip BG-E9, the label might peel off as you repeatedly load and remove the battery pack. If it peels off, affix a new label.

Checking the Remaining Capacity of a Registered Battery Pack

You can check the remaining capacity of any battery pack (even while not installed) and also when it was last used.

Serial No. Date last used

Battery info.			
7c400300	93%	2010/09/21	
c54406dc	98%	2010/09/30	
Register		Delete info.	

Remaining capacity

Look for the serial No.

- Refer to the battery's serial No. label and look for the battery's serial No. on the battery history screen.
- ▶ You can check the respective battery pack's remaining capacity and the date when it was last used.

Deleting the Registered Battery Pack Information

1 Select [Delete info.].

- Follow step 2 on page 269 to select [Delete info.], then press $\langle \text{SET} \rangle$.

2 Select the battery pack information to be deleted.

- Select the battery pack information to be deleted, then press $\langle \text{SET} \rangle$.
- ▶ $\langle \checkmark \rangle$ will appear.
- To delete another battery pack information, repeat this procedure.

3 Press the $\langle \text{trash} \rangle$ button.

- ▶ The confirmation dialog will appear.

4 Select [OK].

- Select [OK], then press $\langle \text{SET} \rangle$.
- ▶ The battery pack information will be deleted, and the screen in step 1 will reappear.

Using a Household Power Outlet

With the AC Adapter Kit ACK-E6 (sold separately), you can connect the camera to a household power outlet and not worry about the remaining battery level.

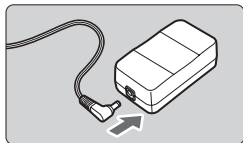

1 Connect the DC Coupler's plug.

- Connect the DC Coupler's plug to the AC Adapter's socket.

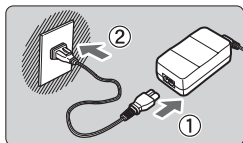

2 Connect the power cord.

- Connect the power cord as shown in the illustration.
- After using the camera, unplug the power plug from the power outlet.

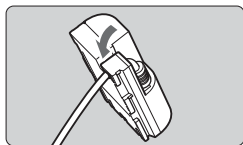

3 Place the cord in the groove.

- Insert the DC Coupler's cord carefully without damaging the cord.

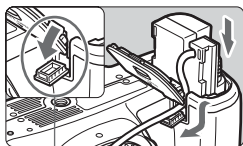

DC Coupler cord hole

4 Insert the DC Coupler.

- Open the battery compartment cover and open the DC Coupler cord notch cover.
- Insert the DC Coupler securely until it locks and put the cord through the notch.
- Close the cover.

! Do not connect or disconnect the power cord while the camera's power switch is set to <ON>.

Using Eye-Fi Cards

With a commercially-available Eye-Fi card already set up, you can automatically transfer captured images to a personal computer or upload them to an online service via a wireless LAN.

The image transfer is a function of the Eye-Fi card. For instructions on how to set up and use the Eye-Fi card or to troubleshoot any image transfer problems, refer to the Eye-Fi card's instruction manual or inquire the card's manufacturer.

⚠ This product is not guaranteed to support Eye-Fi card functions (including wireless transfer). In case of an issue with an Eye-Fi card, please check with the card manufacturer. Also note that approval is required to use Eye-Fi cards in many countries or regions. Without approval, use of the card is not permitted. If it is unclear whether the card has been approved for use in the area, please check with the card manufacturer.

1 Insert an Eye-Fi card. (p.32)



2 Select [Eye-Fi settings].

- Under the [] tab, select [**Eye-Fi settings**], then press <SET>.
- This menu is displayed only when an Eye-Fi card has been inserted into the camera.



3 Enable the Eye-Fi transmission.

- Press <SET>, set [**Eye-Fi trans.**] to [**Enable**], then press <SET>.
- If you set [**Disable**], automatic transmission will not occur even with the Eye-Fi card inserted (Transmission status icon).

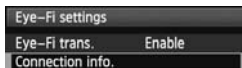

4 Display the connection information.

- Select [**Connection info.**], then press <SET>.



5 Check the [**Access point SSID:**].





- Check that an access point is displayed for [**Access point SSID:**].
- You can also check the Eye-Fi card's MAC address and firmware version.
- Press the <MENU> button three times to exit the menu.

6 Take the picture.

- ▶ The images will be displayed.
- For transferred images,  is displayed in the detailed information display (p.191).



Transmission status icon

-  (Gray) **Not connected** : No connection with access point.
-  (Blinking) **Connecting** : Connecting with access point.
-  (Displayed) **Connected** : Connection to access point established.
-  (↑) **Transferring** : Image transfer to access point in progress.

* To check the Eye-Fi card's transmission status as listed above, press the <INFO.> button to display the shooting settings (p.267).



Cautions for Using Eye-Fi Cards

- If “” is displayed, an error occurred while retrieving the card information. Turn the camera off and on again.
- Even if [**Eye-Fi trans.**] is set to [**Disable**], it may still transmit a signal. In hospitals, airports, and other places where wireless transmissions are prohibited, remove the Eye-Fi card from the camera.
- If the image transfer does not function, check the Eye-Fi card and personal computer settings. For details, see the card's instruction manual.
- Depending on the wireless LAN's connection conditions, the image transfer may take longer or it might be interrupted.
- Because of the transmission function, the Eye-Fi card may become hot.
- The battery power will be consumed faster.
- During the image transfer, auto power off will not take effect.

Function Availability Table According to Shooting Modes

● : Set automatically ○ : User selectable □ : Not selectable

Mode Dial		Basic Zone							Creative Zone					🗨️		
		📷	📹	CA	🌀	🏔️	🌿	🌊	📷	P	Tv	Av	M	B	🗨️	📷
All recording quality settings selectable		○	○	○	○	○	○	○	○	○	○	○	○	○	□	○
ISO speed	Auto	●	●	●	●	●	●	●	○	○	○	○	○	○	○	
	Manual	□	□	□	□	□	□	□	○	○	○	○	○	○	○*	
	Settable maximum ISO speed limit	□	□	□	□	□	□	□	○	○	○	○	○	□	□	
Picture Style	Manual selection	□	□	□	□	□	□	□	○	○	○	○	○	□	○	
	Automatic setting	📷	📷	📷	📷	📷	📷	📷	□	□	□	□	□	□	□	
Shoot by ambience selection		□	□	○	○	○	○	○	□	□	□	□	□	□	□	
Shoot by lighting or scene type		□	□	□	○	○	○	○	□	□	□	□	□	□	□	
White balance	Auto	●	●	●	●	●	●	●	○	○	○	○	○	○	○	
	Preset	□	□	□	□	□	□	□	○	○	○	○	○	○	○	
	Custom	□	□	□	□	□	□	□	○	○	○	○	○	○	○	
	Correction / Bracketing	□	□	□	□	□	□	□	○	○	○	○	○	□	□	
Auto Lighting Optimizer		●	●	●	●	●	●	●	○	○	○	○	○	○	○	
Lens peripheral illumination correction		○	○	○	○	○	○	○	○	○	○	○	○	○	○	
Highlight tone priority		□	□	□	□	□	□	□	○	○	○	○	○	○	○	
Color space	sRGB	●	●	●	●	●	●	●	○	○	○	○	○	□	□	
	Adobe RGB	□	□	□	□	□	□	□	○	○	○	○	○	□	□	
RAW image processing		□	□	□	□	□	□	□	○	○	○	○	○	○	○	
Creative filters		○	○	○	○	○	○	○	○	○	○	○	○	○	○	
Resize		○	○	○	○	○	○	○	○	○	○	○	○	○	○	
Rating		○	○	○	○	○	○	○	○	○	○	○	○	○	○	

* For manual exposure only.

● The 📷 icon indicates still photo shooting in the movie shooting mode.

Mode Dial		Basic Zone							Creative Zone					ⓘ		
										P	Tv	Av	M	B	ⓘ	
AF	One-Shot				●	●	●		●	○	○	○	○	○		●
	AI Servo							●		○	○	○	○	○		
	AI Focus	●	●	●						○	○	○	○	○		
	AF point selection	●	●	●	●	●	●	●	●	○	○	○	○	○		AFQuick
	AF-assist beam	●		●	●		●		●	○	○	○	○	○		
Metering mode	Evaluative	●	●	●	●	●	●	●	○	○	○	○	○			
	Metering mode selection									○	○	○	○	○		
Exposure	Program shift								○							
	Exposure compensation									○	○	○				○
	AEB									○	○	○	○			
	AE lock									○	○	○				○
	Depth-of-field preview									○	○	○	○	○		
Drive	Single shooting	●	●	○		●	●		●	○	○	○	○	○		○
	High-speed continuous							●		○	○	○	○	○		○
	Low-speed continuous			○	●					○	○	○	○	○		○
	10 sec.	○	○	○	○	○	○	○	○	○	○	○	○	○		○
	2 sec.									○	○	○	○	○		○
Built-in flash	Fires automatically	●		○	●		●		●							
	Flash on			○						○	○	○	○	○		
	Flash off		●	○		●		●		○	○	○	○	○		●
	Red-eye reduction	○	○	○	○	○	○	○	○	○	○	○	○	○		
	FE lock									○	○	○	○	○		
	Flash exposure compensation									○	○	○	○	○		
	Wireless control									○	○	○	○	○		
Live View shooting		○	○	○	○	○	○	○	○	○	○	○	○	○		●
Multiple aspect ratios*										○	○	○	○	○		

* Multiple aspect ratios are available only with Live View shooting.

Menu Settings

Shooting 1 (Red)

Page

Quality	L / L / M / M / S1 / S1 / S2 / S3	84
	RAW / M RAW / S RAW	
Beep	Enable / Disable	–
Release shutter without card	Enable / Disable	32
Image review	Off / 2 sec. / 4 sec. / 8 sec. / Hold	50
Peripheral illumination correction	Enable / Disable	102
Red-eye reduction	Disable / Enable	131
Flash control	Flash firing / Built-in flash function setting / External flash function setting / External flash C.Fn setting / Clear external flash C.Fn setting	135

Shooting 2 (Red)

Exposure compensation/AEB	1/3-stop increments, ± 5 stops (AEB ± 3 stops)	121
Auto Lighting Optimizer	Disable / Low / Standard / Strong	101
Picture Style	Standard / Portrait / Landscape / Neutral / Faithful / Monochrome / User Def. 1, 2, 3	90-95
White balance	AWB / / / / / / / / / (Approx. 2500 - 10000)	96
Custom White Balance	Manual setting of white balance	97
WB Shift/BKT	WB correction: White balance correction	99
	WB-BKT: White balance bracketing	100
Color space	sRGB / Adobe RGB	110



Shooting 3 (Red)

Dust Delete Data	Obtains data to be used to erase dust spots	231
ISO Auto	Max.: 400 / Max.: 800 / Max.: 1600 / Max.: 3200 / Max.: 6400	89

Shaded menu options are not displayed in Basic Zone modes.

Shooting 4 (Red)







Page

Live View shooting	Enable / Disable	157
AF mode	Live mode /  Live mode / Quick mode	160
Grid display	Off / Grid 1  / Grid 2 	157
Aspect ratio	3:2 / 4:3 / 16:9 / 1:1	157
Exposure simulation	Enable / Disable	158
Silent shooting	Mode 1 / Mode 2 / Disable	159
Metering timer	4 sec. / 16 sec. / 30 sec. / 1 min. / 10 min. / 30 min.	159

Playback 1 (Blue)

Protect images	Erase-protect images	213
Rotate	Rotate vertical images	197
Erase images	Erase images	215
Print order	Specify images to be printed (DPOF)	245
Creative filters	Grainy B/W / Soft focus / Toy camera effect / Miniature effect	220
Resize	Downsize the image's pixel count	222
RAW image processing	Process RAW images	224

Playback 2 (Blue)

Highlight alert	Disable / Enable	192
AF point display	Disable / Enable	193
Histogram	Brightness / RGB	193
Image jump w/ 	1 image / 10 images / 100 images / Date / Folder / Movies / Stills / Rating	195
Slide show	Select the images, Play time, Repeat, and Transition effect for auto playback	207
Rating	[OFF] / [] / [] / [] / [] / []	198
Control over HDMI	Disable / Enable	211

☛ Set-up 1 (Yellow)

Page

Auto power off	1min. / 2 min. / 4 min. / 8 min. / 15 min. / 30 min. / Off	50
Auto rotate	On / On / Off	218
Format	Initialize and erase data on the card	48
File numbering	Continuous / Auto reset / Manual reset	106
Select folder	Create and select a folder	104
Eye-Fi settings*	Eye-Fi transmission: Disable / Enable Connection information	273

* Displayed only when an Eye-Fi card is used.

☛ Set-up 2 (Yellow)

LCD brightness	Adjustable to one of seven brightness levels	217
Date/Time	Set the date (year, month, day) and time (hour, min., sec.)	30
Language 	Select the interface language	31
Video system	NTSC / PAL	212
Sensor cleaning	Auto cleaning: Enable / Disable	230
	Clean now	
	Clean manually	233
Lock 	Disable / Enable	42

☛ Set-up 3 (Yellow)

Battery info.	Type, Remaining capacity, Shutter count, Recharge performance, Battery registration, Battery history	268
INFO. button display options	Displays camera settings / Electronic level / Displays shooting functions	266
Camera user settings	Register current camera settings to the Mode Dial's <C> position	262
Copyright information	Display copyright information / Enter author's name / Enter copyright details / Delete copyright information	108
Clear all camera settings	Resets the camera to the default settings	51
Firmware Ver.	For updating the firmware	–

Custom Functions (Orange)

Page







C.Fn I : Exposure	Customize camera functions as desired	252
C.Fn II : Image		254
C.Fn III : Autofocus/ Drive		255
C.Fn IV : Operation/ Others		257
Clear all Custom Functions (C.Fn)	Clears all Custom Function settings	250

★ My Menu (Green)

My Menu settings	Register frequently-used menu items and Custom Functions	261
-------------------------	--	-----











Movie Shooting Mode Menus

Movie 1 (Red)



















Movie exposure	Auto / Manual	182
AF mode	Live mode /  Live mode / Quick mode	182
AF w/ shutter button during 	Disable / Enable	182
AF and metering buttons for 	Customize the shutter button, <AF-ON> button, and <  > button	183
 ISO speed setting increments	1/3-stop / 1-stop	183
 Highlight tone priority	Disable / Enable	183

 **Movie 2 (Red)**











Page

Movie recording size	1920x1080 ( /  / ) / 1280x720 ( / ) / 640x480 ( / ) / Crop 640x480 ( / )	180
Sound recording	Sound recording: Auto / Manual / Disable	184
	Recording level	
	Wind filter: Disable / Enable	
Silent shooting	Mode 1 / Mode 2 / Disable	185
Metering timer	4 sec. / 16 sec. / 30 sec. / 1 min. / 10 min. / 30 min.	185
Grid display	Off / Grid 1  / Grid 2 	185

 **Movie 3 (Red)**

Exposure compensation	1/3-stop increments, ±5 stops	186
Auto Lighting Optimizer	Disable / Low / Standard / Strong	186
Picture Style	 Standard /  Portrait /  Landscape /  Neutral /  Faithful /  Monochrome /  User Def. 1, 2, 3	186
White balance	 AWB /  /  /  /  /  /  /  /  /  /  (Approx. 2500 - 10000)	186
Custom White Balance	Manual setting of white balance	186

 **About the menu screen in movie shooting mode**

- The [] Movie 1, [] Movie 2, and [] Movie 3 screens (tabs) are displayed only in the movie shooting mode.
- The [] Shooting 2, [] Shooting 3, [] Shooting 4, [] Custom Function, and [] My Menu screens (tabs) will not be displayed.
- The following menu items will not be displayed:
 - []: Red-eye reduction, Flash control
 - []: INFO. button display options, Camera user settings, Copyright information, Clear all camera settings, Firmware Ver.

Troubleshooting Guide

If a problem occurs with the camera, first refer to this Troubleshooting Guide. If this Troubleshooting Guide does not resolve the problem, contact your dealer or nearest Canon Service Center.

Power-Related Problems

The battery pack does not recharge.

- If the battery's remaining capacity (p.268) is 94% or higher, the battery will not be recharged.
- Do not recharge any battery pack other than genuine Canon Battery Pack LP-E6.

The charger's lamp blinks at high speed.

- If there is a problem with the battery charger or battery pack or if communication with the battery pack (non-Canon battery packs) is not possible, the protective circuit will terminate the charging and the orange lamp will blink quickly at a regular interval. If there is a problem with the battery charger or battery pack, unplug the charger's power plug from the power outlet. Detach and reattach the battery pack to the charger. Wait 2 to 3 minutes, then reconnect the power plug to the power outlet. If the problem persists, contact your dealer or nearest Canon Service Center.

The charger's lamp does not blink.

- If the internal temperature of the battery pack attached to the charger is high, the charger will not charge the battery for safety reasons (lamp off). During the charging, if the battery's temperature becomes high for any reason, the charging will stop automatically (lamp blinks). When the battery temperature goes down, the charging will resume automatically.

The camera does not operate even when the power switch is set to <ON>.

- The battery is not properly installed in the camera (p.26).
- Recharge the battery (p.24).
- Make sure the battery compartment cover is closed (p.26).
- Make sure the card slot cover is closed (p.32).

The access lamp still blinks even when the power switch is set to <OFF>.

- If the power is turned off while an image is being recorded to the card, the access lamp will still continue to light/blink for a few seconds. When the image recording is completed, the power will turn off automatically.

The battery becomes exhausted quickly.

- Use a fully-charged battery pack (p.24).
- The battery performance might have degraded. See the [ **Battery info.**] menu option to check the battery's performance level (p.268). If the battery performance is poor, replace the battery pack with a new one.
- If you keep displaying the Quick Control screen (p.44) or do Live View shooting or movie shooting (p.151, 171) for a prolonged period, the number of possible shots will decrease.

The camera turns off by itself.

- Auto power off is in effect. If you do not want auto power off to take effect, set [ **Auto power off**] to [Off].

Shooting-Related Problems

No images can be shot nor recorded.

- The card is not properly inserted (p.32).
- If the card is full, replace the card or delete unnecessary images to make room (p.32, 215).
- If you try to focus in the One-Shot AF mode while the focus confirmation light <●> in the viewfinder blinks, a picture cannot be taken. Press the shutter button halfway again to focus, or focus manually (p.40, 80).
- Slide the card's write-protect switch to the Write/Erase setting (p.32).

The card cannot be used.

- If a card error message is displayed, see page 33 or 291.

The image is out of focus.

- Set the lens focus mode switch to **<AF>** (p.34).
- To prevent camera shake, press the shutter button gently (p.39, 40).
- If the lens has an Image Stabilizer, set the IS switch to **<ON>**.

The maximum burst during continuous shooting is lower.

- Set [**C.Fn II -2: High ISO speed noise reduction**] to one of the following settings: [**Standard/Low/Disable**]. If it is set to [**Strong**], the maximum burst during continuous shooting will greatly decrease (p.254).
- If you shoot something that has fine detail (field of grass, etc.), the file size will be larger and the actual maximum burst might be lower than the number mentioned on page 85.

ISO 100 cannot be set.

- If [**C.Fn II -3: Highlight tone priority**] is set to [**Enable**], ISO 100 cannot be set. If [**Disable**] is set, ISO 100 can be set (p.255). This also applies to movie shooting (p.183).

The Auto Lighting Optimizer cannot be set.

- If [**C.Fn II -3: Highlight tone priority**] is set to [**Enable**], the Auto Lighting Optimizer cannot be set. When [**Highlight tone priority**] is set to [**Disable**], then the Auto Lighting Optimizer can be set (p.255). This also applies to movie shooting (p.183).

When I use the <Av> mode with flash, the shutter speed becomes slow.

- If you shoot at night when the background is dark, the shutter speed becomes slow automatically (slow-sync shooting) so that both the subject and background are properly exposed. If you do not want a slow shutter speed to be set, set [ C.Fn I -7: Flash sync. speed in Av mode] to 1 or 2 (p.253).

The built-in flash does not fire.

- If you shoot continuously with the built-in flash at short intervals, the flash might stop operating to protect the flash unit.

Flash exposure compensation cannot be set.

- If flash exposure compensation has already been set with the Speedlite, flash exposure compensation cannot be set with the camera. When the Speedlite's flash exposure compensation is canceled (set to 0), flash exposure compensation can be set with the camera.

High-speed sync cannot be set in the Av mode.

- Set [ C.Fn I -7: Flash sync. speed in Av mode] to [0: Auto] (p.253).

The external flash does not fire.

- If you use a non-Canon flash with Live View shooting, set the [ Silent shoot.] menu option to [Disable] (p.159).

The camera makes a noise when it is shaken.

- The built-in flash's pop-up mechanism moves slightly. This is normal.

The shutter makes two shooting sounds during Live View shooting.

- If you use flash, the shutter will make two sounds each time you shoot (p.153).

The camera button/dial's function has changed.

- On the Quick Control screen, check the [Custom Controls] setting (p.257).

Movie shooting terminates by itself.

- If the card's writing speed is slow, movie shooting may stop automatically. Use an SD Speed Class 6 "CLASS 6" or faster card. To find out the card's read/write speed, see the card manufacturer's Web site, etc.
- The movie shooting will be terminated automatically if the file size reaches 4 GB or if the movie length reaches 29 min. 59 sec.

During Live View and movie shooting, a white <🌡️> or red <🌡️> icon is displayed.

- Both icons indicate that the camera's internal temperature is high. If the white <🌡️> icon appears, the still photo's image quality might deteriorate. The red <🌡️> icon indicates that the Live View or movie shooting will soon be terminated automatically (p.152, 173).

The movie sometimes freezes momentarily.

- If there is a drastic change in the exposure during movie shooting, the autoexposure stops the recording until the exposure stabilizes. If this happens, use manual exposure.

The movie cannot play.

- Movies edited with a personal computer using the provided software, etc., cannot be played with the camera.

When the movie is played, camera operation noise can be heard.

- If you operate the camera's dials or lens during movie shooting, the operation noise will also be recorded. Use an external microphone (commercially available) (p.187).

Display & Operation Problems

The LCD monitor does not display a clear image.

- If the LCD monitor is dirty, use a soft cloth to clean it.
- In low or high temperatures, the LCD monitor display may seem slow or might look black. It will return to normal at room temperature.

The menu screen shows few tabs and options.

- In Basic Zone modes and in movie shooting mode, certain tabs and menu options are not displayed. Set the shooting mode to a Creative Zone mode (p.46).

The image cannot be erased.

- If the image has been protected, it cannot be erased (p.213).

Part of the image blinks in black.

- The [ Highlight alert] menu option is set to [Enable] (p.192).

A red box is displayed on the image.

- The [ AF point disp.] menu option is set to [Enable] (p.193).

The file name's first character is an underscore (“_MG_”).

- Set the color space to sRGB. If Adobe RGB is set, the first character will be an underscore (p.110).

The file numbering does not start from 0001.

- If you use a card which already has images recorded, the file numbering might start from the last image in the card (p.106).

The shooting date and time displayed is incorrect.

- The correct date and time has not been set (p.30).

No image appears on the TV screen.

- Make sure the AV cable or HDMI cable's plug is inserted all the way in (p.209, 212).
- Set the video OUT system (NTSC/PAL) to the same video system as the TV set (p.212).
- Use the AV cable that came with the camera (p.212).

The card reader does not detect the card.

- Depending on the card reader and computer OS used, SDXC cards might not be correctly detected. In such a case, connect your camera and computer with the provided interface cable, and transfer the images to your computer using EOS Utility (provided software).

[###] is displayed.

- [###] will be displayed when the number of images/movies exceeds the number of digits that can be displayed.

The [Eye-Fi settings] menu item does not appear.

- [Eye-Fi settings] will appear only when an Eye-Fi card is inserted into the camera. If the Eye-Fi card has a write-protect tab set to the LOCK position, you will not be able to check the card's connection status or disable Eye-Fi card transmission.

Printing-Related Problems

There are fewer printing effects than listed in the instruction manual.

- What is displayed on the screen differs depending on the printer. This instruction manual lists all the printing effects available (p.240).

Error Codes

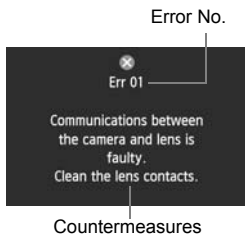

If there is a problem with the camera, an error message will appear. Follow the on-screen instructions.

No.	Error Message & Solution
01	Communications between the camera and lens is faulty. Clean the lens contacts.
	→ Clean the electrical contacts on the camera and lens and use a Canon lens (p.13, 16).
02	Card cannot be accessed. Reinsert/change card or format card with camera.
	→ Remove and insert the card again, replace the card, or format the card (p.32, 48).
04	Cannot save images because card is full. Replace card.
	→ Replace the card, erase unnecessary images, or format the card (p.32, 48, 215).
05	The built-in flash could not be raised. Turn the camera off and on again.
	→ Operate the power switch (p.28).
06	Sensor cleaning is not possible. Turn the camera off and on again.
	→ Operate the power switch (p.28).
10, 20, 30, 40, 50, 60, 70, 80	Shooting is not possible due to an error. Turn the camera off and on again or re-install the battery.
	→ Operate the power switch, remove and install the battery pack again, or use a Canon lens (p.26, 28).

* If the error still persists, write down the error No. and contact your nearest Canon Service Center.

System Map

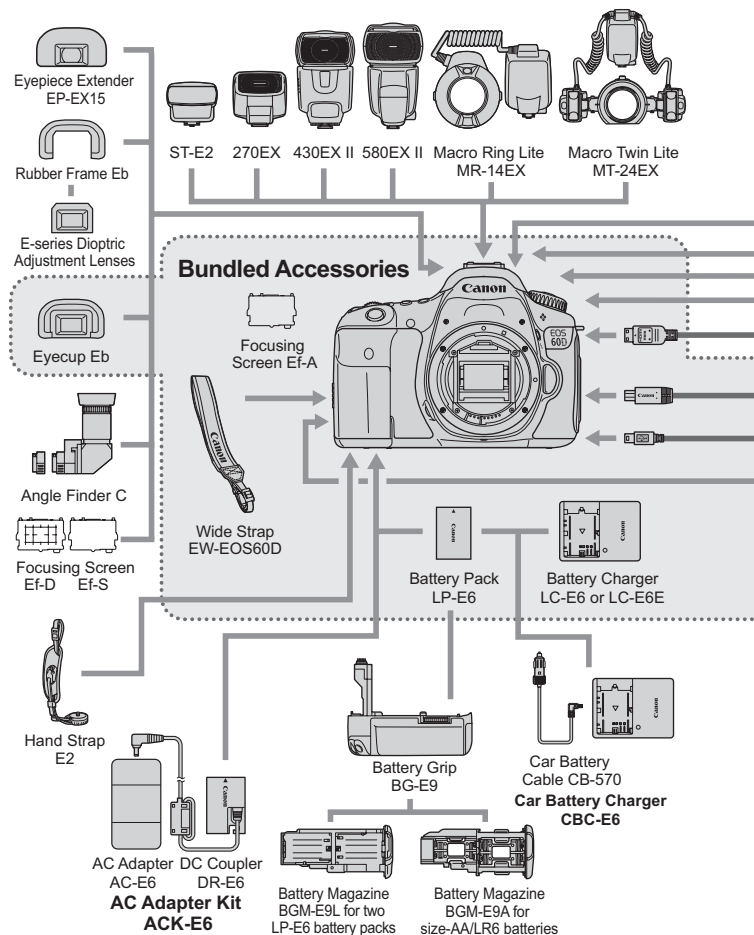

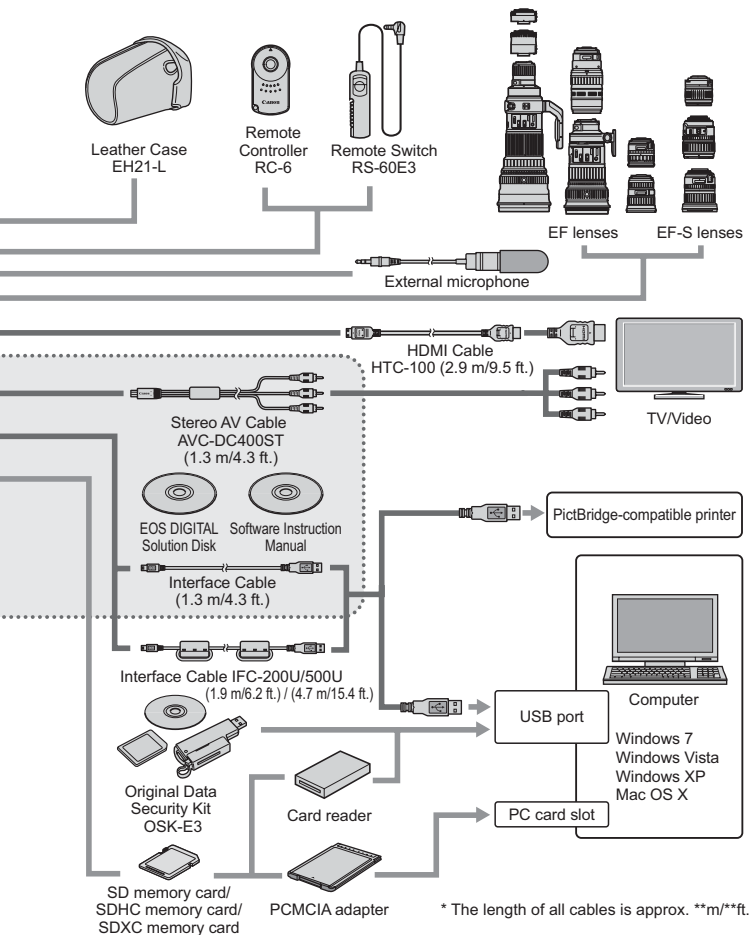

Specifications

• Type

Type:	Digital, single-lens reflex, AF/AE camera with built-in flash
Recording media:	SD memory card, SDHC memory card, SDXC memory card
Image sensor size:	22.3 x 14.9 mm
Compatible lenses:	Canon EF lenses (including EF-S lenses) (35mm-equivalent focal length is approx. 1.6 times the lens focal length)
Lens mount:	Canon EF mount

• Image Sensor

Type:	CMOS sensor
Effective pixels:	Approx. 18.00 megapixels
Aspect ratio:	3:2
Dust delete feature:	Auto, Manual, Dust Delete Data appending

• Recording System

Recording format:	Design rule for Camera File System 2.0
Image type:	JPEG, RAW (14-bit Canon original) RAW+JPEG simultaneous recording possible
Recorded pixels:	Large : Approx. 17.90 megapixels (5184 x 3456) Medium : Approx. 8.00 megapixels (3456 x 2304) S1 (Small 1) : Approx. 4.50 megapixels (2592 x 1728) S2 (Small 2) : Approx. 2.50 megapixels (1920 x 1280) S3 (Small 3) : Approx. 350,000 pixels (720 x 480) RAW : Approx. 17.90 megapixels (5184 x 3456) M-RAW : Approx. 10.10 megapixels (3888 x 2592) S-RAW : Approx. 4.50 megapixels (2592 x 1728)
Create/select a folder:	Possible

• Image Processing During Shooting

Picture Style:	Standard, Portrait, Landscape, Neutral, Faithful, Monochrome, User Def. 1 - 3
Basic+:	Shoot by ambience selection, Shoot by lighting or scene type
White balance:	Auto, Preset (Daylight, Shade, Cloudy, Tungsten light, White fluorescent light, Flash), Custom, Color temperature setting (Approx. 2500-10000K), white balance correction, and white balance bracketing possible * Color temperature information transmission enabled
Noise reduction:	Applicable to long exposures and high ISO speed shots

Automatic image

brightness correction:	Auto Lighting Optimizer
Highlight tone priority:	Provided
Lens peripheral illumination correction:	Provided

• Viewfinder

Type:	Eye-level pentaprism
Coverage:	Vertical/Horizontal approx. 96% (with Eye point approx. 22 mm)
Magnification:	Approx. 0.95x (-1 m ⁻¹ with 50mm lens at infinity)
Eye point:	Approx. 22 mm (From eyepiece lens center at -1 m ⁻¹)
Built-in dioptic adjustment:	Approx. -3.0 - +1.0 m ⁻¹ (dpt)
Focusing screen:	Interchangeable (Two types sold separately), Ef-A provided
Electronic level:	Horizontal level displayed up to ±9° in ±1° increments (For horizontal shooting only)
Mirror:	Quick-return type
Depth-of-field preview:	Provided

• Autofocus

Type:	TTL secondary image-registration, phase detection
AF points:	9 (All cross-type)
Metering range:	EV -0.5 - 18 (at 23°C/73°F, ISO 100)
Focus modes:	One-Shot AF, AI Servo AF, AI Focus AF, Manual focusing (MF)
AF-assist beam:	Small series of flashes fired by built-in flash

• Exposure Control

Metering modes:	63-zone TTL full-aperture metering <ul style="list-style-type: none"> • Evaluative metering (linked to all AF points) • Partial metering (approx. 6.5% of viewfinder at center) • Spot metering (approx. 2.8% of viewfinder at center) • Center-weighted average metering
Metering range:	EV 1 - 20 (at 23°C/73°F with EF50mm f/1.4 USM lens, ISO 100)
Exposure control:	Program AE (Full Auto, Flash Off, Creative Auto, Portrait, Landscape, Close-up, Sports, Night Portrait, Program), shutter-priority AE, aperture-priority AE, manual exposure, bulb exposure
ISO speed:	Basic Zone modes: ISO 100 - 3200 set automatically
(Recommended exposure index)	Creative Zone modes: ISO 100 - 6400 set manually (1/3-stop increments), ISO 100 - 6400 set automatically, or ISO expansion to "H" (equivalent to ISO 12800)

Exposure compensation:	Manual: ± 5 stops in 1/3- or 1/2-stop increments AEB: ± 3 stops in 1/3- or 1/2-stop increments (Can be combined with manual exposure compensation)
AE lock:	Auto: Applied in One-Shot AF mode with evaluative metering when focus is achieved Manual: By AE lock button

• Shutter

Type:	Electronically-controlled, focal-plane shutter
Shutter speeds:	1/8000 sec. to 1/60 sec. (Full Auto mode), Flash X-sync at maximum 1/250 sec. 1/8000 sec. to 30 sec., bulb (Total shutter speed range. Available range varies by shooting mode.)

• Flash

Built-in flash:	Retractable, auto pop-up flash Guide No.: Approx. 13/43 (ISO 100, in meters/feet) Flash coverage: Approx. 17mm lens angle of view Recycling time approx. 3 sec. Wireless master unit function provided
External flash:	EX-series Speedlite (Flash functions settable with the camera)
Flash metering:	E-TTL II autoflash
Flash exposure compensation:	± 3 stops in 1/3- or 1/2-stop increments
FE lock:	Provided
PC terminal:	None

• Drive System

Drive modes:	Single, High-speed continuous, Low-speed continuous, 10-sec. self-timer/remote control, 2-sec. self-timer/remote control
Continuous shooting speed:	Max. approx. 5.3 shots/sec.
Max. burst:	JPEG Large/Fine: Approx. 58 shots RAW: Approx. 16 shots RAW+JPEG Large/Fine: Approx. 7 shots
	* Figures are based on Canon's testing standards (ISO 100 and Standard Picture Style) and a 4GB card.

• Live View Shooting

Aspect ratio settings:	3:2, 4:3, 16:9, 1:1
Focusing:	Live mode, Face detection Live mode (Contrast detection) Quick mode (Phase-difference detection) Manual focusing (Approx. 5x / 10x magnification possible)
Metering modes:	Evaluative metering with the image sensor
Metering range:	EV 0 - 20 (at 23°C/73°F with EF50mm f/1.4 USM lens, ISO 100)
Silent shooting:	Provided (Mode 1 and 2)
Grid display:	Two types

• Movie Shooting

Movie compression:	MPEG-4 AVC/H.264 Variable (average) bit rate
Audio recording format:	Linear PCM
Recording format:	MOV
Recording size and frame rate:	1920x1080 (Full HD) : 30p/25p/24p 1280x720 (HD) : 60p/50p 640x480 (SD) : 60p/50p Crop 640x480 (SD) : 60p/50p * 30p: 29.97 fps, 25p: 25.00 fps, 24p: 23.976 fps, 60p: 59.94 fps, 50p: 50.00 fps
File size:	1920x1080 (30p/25p/24p) : Approx. 330 MB/min. 1280x720 (60p/50p) : Approx. 330 MB/min. 640x480 (60p/50p) : Approx. 165 MB/min. Crop 640x480 (60p/50p) : Approx. 165 MB/min.
Focusing:	Same as focusing with Live View shooting
Metering modes:	Center-weighted average and evaluative metering with the image sensor * Automatically set by the focusing mode
Metering range:	EV 0 - 20 (at 23°C/73°F with EF50mm f/1.4 USM lens, ISO 100)
Exposure control:	Program AE (exposure compensation possible) for movies, manual exposure
Exposure compensation:	±3 stops in 1/3-stop increments (Still photos: ±5 stops)
ISO speed:	Automatically set within ISO 100 - 6400
(Recommended exposure index)	With manual exposure, ISO 100 - 6400 set automatically/manually

Sound recording:	Built-in monaural microphone External stereo microphone terminal provided Sound recording level adjustable, wind filter provided
Grid display:	Two types

• LCD Monitor

Type:	TFT color, liquid-crystal monitor
Monitor size and dots:	Wide, 3.0-in. (3:2) with approx. 1.04 million dots
Coverage:	Approx. 100%
Angle adjustment:	Possible
Brightness adjustment:	Manual (7 levels)
Electronic level:	Horizontal level displayed in 1° increments
Interface languages:	25

• Image Playback

Image display formats:	Single image, Single image + Info (Basic info, detailed info, histogram), 4-image index, 9-image index, image rotate possible
Zoom magnification:	Approx. 1.5x - 10x
Image browsing methods:	Single image, jump by 10 or 100 images, by shooting date, by folder, by movie, by stills, by rating
Highlight alert:	Overexposed highlights blink
Slide show:	All images, by date, by folder, movies, stills, or by rating Three transition effects selectable
Movie playback:	Enabled (LCD monitor, video/audio OUT, HDMI OUT) Built-in speaker

• Post-Processing of Images

In-camera RAW image processing:	Brightness adjustment, white balance, Picture Style, Auto Lighting Optimizer, noise reduction at high ISO speeds, JPEG recording quality, color space, peripheral illumination correction, distortion correction, and chromatic aberration correction
Creative filters:	Grainy B/W, Soft focus, Toy camera effect, Miniature effect
Resize:	Possible
Ratings:	Provided

• Direct Printing

Compatible printers:	PictBridge-compatible printers
Printable images:	JPEG and RAW images
Print ordering:	DPOF Version 1.1 compatible

• Custom Functions

Custom Functions:	20
Camera user settings:	Register under Mode Dial's C
My Menu registration:	Possible
Copyright information:	Entry and inclusion enabled

• Interface

Audio/video OUT/ Digital terminal:	Analog video (Compatible with NTSC/PAL)/stereo audio output For personal computer communication and direct printing (Hi-Speed USB equivalent)
HDMI mini OUT terminal:	Type C (Auto switching of resolution), CEC-compatible
External microphone IN terminal:	3.5mm dia. stereo mini-jack
Remote control terminal:	For Remote Switch RS-60E3
Wireless remote control:	Remote Controller RC-6

• Power

Battery:	Battery Pack LP-E6 (Quantity 1) * AC power can be supplied via AC Adapter Kit ACK-E6 * With Battery Grip BG-E9 attached, size-AA/LR6 batteries can be used
Battery information:	Remaining capacity, Shutter count, and Recharge performance displayed
Battery life: (Based on CIPA testing standards)	With viewfinder shooting: Approx. 1100 shots at 23°C/73°F, approx. 1000 shots at 0°C/32°F With Live View shooting: Approx. 320 shots at 23°C/73°F, approx. 280 shots at 0°C/32°F
Movie shooting time:	Approx. 2 hours at 23°C/73°F Approx. 1 hr. 40 min. at 0°C/32°F (With a fully-charged Battery Pack LP-E6)

• Dimensions and Weight

Dimensions (W x H x D):	Approx. 144.5 x 105.8 x 78.6 mm / 5.7 x 4.2 x 3.1 in.
Weight:	Approx. 755 g / 26.6 oz. (CIPA Guidelines), Approx. 675 g / 23.8 oz. (Body only)

• Operation Environment

Working temperature range:	0°C - 40°C / 32°F - 104°F
Working humidity:	85% or less

• **Battery Pack LP-E6**

Type:	Rechargeable lithium-ion battery
Rated voltage:	7.2 V DC
Battery capacity:	1800 mAh
Dimensions (W x H x D):	Approx. 38.4 x 21.0 x 56.8 mm / 1.5 x 0.8 x 2.2 in.
Weight:	Approx. 80 g / 2.8 oz.

• **Battery Charger LC-E6**

Compatible battery:	Battery Pack LP-E6
Recharging time:	Approx. 2 hr. 30 min.
Rated input:	100 - 240 V AC (50/60 Hz)
Rated output:	8.4 V DC / 1.2A
Working temperature range:	5°C - 40°C / 41°F - 104°F
Working humidity:	85% or less
Dimensions (W x H x D):	Approx. 69.0 x 33.0 x 93.0 mm / 2.7 x 1.3 x 3.7 in.
Weight:	Approx. 130 g / 4.6 oz.

• **Battery Charger LC-E6E**

Compatible battery:	Battery Pack LP-E6
Power cord length:	Approx. 1 m / 3.3 ft.
Recharging time:	Approx. 2 hours 30 min.
Rated input:	100 - 240 V AC (50/60 Hz)
Rated output:	8.4 V DC/1.2A
Working temperature range:	5°C - 40°C / 41°F - 104°F
Working humidity:	85% or less
Dimensions (W x H x D):	Approx. 69.0 x 33.0 x 93.0 mm / 2.7 x 1.3 x 3.7 in.
Weight:	Approx. 125 g / 4.4 oz. (excluding power cord)

• EF-S18-55mm f/3.5-5.6 IS II

Angle of view:	Diagonal extent: 74°20' - 27°50' Horizontal extent: 64°30' - 23°20' Vertical extent: 45°30' - 15°40'
Lens construction:	11 elements in 9 groups
Minimum aperture:	f/22 - 36
Closest focusing distance:	0.25 m / 0.82 ft. (From image sensor plane)
Max. magnification:	0.34x (at 55 mm)
Field of view:	207 x 134 - 67 x 45 mm / 8.1 x 5.3 - 2.6 x 1.8 in. (at 0.25 m / 0.82 ft.)
Image Stabilizer:	Lens shift type
Filter size:	58 mm
Lens cap:	E-58
Max. diameter x length:	Approx. 68.5 x 70.0 mm / 2.7 x 2.8 in.
Weight:	Approx. 200 g / 7.1 oz.
Hood:	EW-60C (sold separately)
Case:	LP814 (sold separately)

• EF-S15-85mm f/3.5-5.6 IS USM

Angle of view:	Diagonal extent: 84°30' - 18°25' Horizontal extent: 74°10' - 15°25' Vertical extent: 53°30' - 10°25'
Lens construction:	17 elements in 12 groups
Minimum aperture:	f/22 - 36
Closest focusing distance:	0.35 m / 1.15 ft. (From image sensor plane)
Max. magnification:	0.21x (at 85mm)
Field of view:	255 x 395 - 72 x 108 mm / 10.0 x 15.6 - 2.8 x 4.3 in. (at 0.35 m / 1.15 ft.)
Image Stabilizer:	Lens shift type
Filter size:	72 mm
Lens cap:	E-72U
Max. diameter x length:	Approx. 81.6 x 87.5 mm / 3.2 x 3.4 in.
Weight:	Approx. 575 g / 20.3 oz.
Hood:	EW-78E (sold separately)
Case:	LP1116 (sold separately)

• **EF-S18-135mm f/3.5-5.6 IS**

Angle of view:	Diagonal extent: 74°20' - 11°30' Horizontal extent: 64°30' - 9°30' Vertical extent: 45°30' - 6°20'
Lens construction:	16 elements in 12 groups
Minimum aperture:	f/22 - 36
Closest focusing distance*:	At 18mm focal length: 0.49 m / 1.61 ft. (327 x 503 mm / 12.9 x 19.8 in. field of view) At 135mm focal length: 0.45 m / 1.48 ft. (75 x 112 mm / 3.0 x 4.4 in. field of view) * Distance from image sensor plane
Max. magnification:	0.21x (at 135mm)
Image Stabilizer:	Lens shift type
Filter size:	67 mm
Lens cap:	E-67
Max. diameter x length:	Approx. 75.4 x 101.0 mm / 3.0 x 4.0 in.
Weight:	Approx. 455 g / 16.0 oz.
Hood:	EW-73B (sold separately)
Case:	LP1116 (sold separately)

• **EF-S18-200mm f/3.5-5.6 IS**

Angle of view:	Diagonal extent: 74°20' - 7°50' Horizontal extent: 64°30' - 6°30' Vertical extent: 45°30' - 4°20'
Lens construction:	16 elements in 12 groups
Minimum aperture:	f/22 - 36
Closest focusing distance:	0.45 m / 1.48 ft. (From image sensor plane)
Max. magnification:	0.24x (at 200mm)
Field of view:	452 x 291 - 93 x 62 mm / 17.8 x 11.5 - 3.7 x 2.4 in. (at 0.45 m / 1.48 ft.)
Image Stabilizer:	Lens shift type
Filter size:	72 mm
Lens cap:	E-72
Max. diameter x length:	Approx. 78.6 x 102.0 mm / 3.1 x 4.0 in.
Weight:	Approx. 595 g / 21.0 oz.
Hood:	EW-78D (sold separately)
Case:	LP1116 (sold separately)

• EF-S17-85mm f/4-5.6 IS USM

Angle of view:	Diagonal extent: 78°30' - 18°25' Horizontal extent: 68°40' - 15°25' Vertical extent: 48°00' - 10°25'
Lens construction:	17 elements in 12 groups
Minimum aperture:	f/22 - 32
Closest focusing distance:	0.35 m / 1.15 ft. (From image sensor plane)
Max. magnification:	0.2x (at 85mm)
Field of view:	328 x 219 - 112 x 75 mm / 12.9 x 8.6 - 4.4 x 3.0 in. (at 0.35 m)
Image Stabilizer:	Lens shift type
Filter size:	67 mm
Lens cap:	E-67U
Max. diameter x length:	Approx. 78.5 x 92.0 mm / 3.1 x 3.6 in.
Weight:	Approx. 475 g / 16.8 oz.
Hood:	EW-73B (sold separately)
Case:	LP1116 (sold separately)

- All specifications above are based on Canon's testing standards.
- Dimensions, maximum diameter, length and weight listed above are based on CIPA Guidelines (except weight for camera body only).
- Product specifications and the exterior are subject to change without notice.
- If a problem occurs with a non-Canon lens attached to the camera, consult the respective lens maker.

Trademarks

- Adobe is a trademark of Adobe Systems Incorporated.
- Windows is a trademark or registered trademark of Microsoft Corporation in the United States and other countries.
- Macintosh and Mac OS are trademarks or registered trademarks of Apple Inc. in the United States and other countries.
- SDXC logo is a trademark of SD-3C, LLC.
- HDMI, HDMI logo, and High-Definition Multimedia Interface are a trademark or registered trademark of HDMI Licensing LLC.
- All other corporate and product names and trademarks mentioned in this manual are the property of their respective owners.

About MPEG-4 Licensing

"This product is licensed under AT&T patents for the MPEG-4 standard and may be used for encoding MPEG-4 compliant video and/or decoding MPEG-4 compliant video that was encoded only (1) for a personal and non-commercial purpose or (2) by a video provider licensed under the AT&T patents to provide MPEG-4 compliant video. No license is granted or implied for any other use for MPEG-4 standard."

* Notice displayed in English as required.

Use of genuine Canon accessories is recommended

This product is designed to achieve excellent performance when used with genuine Canon accessories. Canon shall not be liable for any damage to this product and/or accidents such as fire, etc., caused by the malfunction of non-genuine Canon accessories (e.g., a leakage and/or explosion of a battery pack). Please note that this warranty does not apply to repairs arising out of the malfunction of non-genuine Canon accessories, although you may request such repairs on a chargeable basis.

 Battery Pack LP-E6 is dedicated to Canon products only. Using it with an incompatible battery charger or product may result in malfunction or accidents for which Canon cannot be held liable.

Safety Warnings

Follow these safeguards and use the equipment properly to prevent injury, death, and material damage.

Preventing Serious Injury or Death

- To prevent fire, excessive heat, chemical leakage, and explosions, follow the safeguards below:
 - Do not use any batteries, power sources, and accessories not specified in this booklet. Do not use any home-made or modified batteries.
 - Do not short-circuit, disassemble, or modify the battery pack or back-up battery. Do not apply heat or apply solder to the battery pack or back-up battery. Do not expose the battery pack or back-up battery to fire or water. And do not subject the battery pack or back-up battery to strong physical shock.
 - Do not install the battery pack or back-up battery in reversed polarity (+ -). Do not mix new and old or different types of batteries.
 - Do not recharge the battery pack outside the allowable ambient temperature range of 0°C - 40°C (32°F - 104°F). Also, do not exceed the recharging time.
 - Do not insert any foreign metallic objects into the electrical contacts of the camera, accessories, connecting cables, etc.
- Keep the back-up battery away from children. If a child swallows the battery, consult a physician immediately. (Battery chemicals may harm the stomach and intestines.)
- When disposing of a battery pack or back-up battery, insulate the electrical contacts with tape to prevent contact with other metallic objects or batteries. This is to prevent fire or an explosion.
- If excessive heat, smoke, or fumes are emitted during battery pack recharging, immediately unplug the battery charger from the power outlet to stop the recharging and prevent a fire.
- If the battery pack or back-up battery leaks, changes color, deforms, or emits smoke or fumes, remove it immediately. Be careful not to get burned in the process.
- Prevent any battery leakage from contacting your eyes, skin, and clothing. It can cause blindness or skin problems. If the battery leakage contacts your eyes, skin, or clothing, flush the affected area with lots of clean water without rubbing it. See a physician immediately.
- During the recharging, keep the equipment away from the reach of children. The cord can accidentally choke the child or give an electrical shock.
- Do not leave any cords near a heat source. It can deform the cord or melt the insulation and cause a fire or electrical shock.
- Do not fire the flash at someone driving a car. It may cause an accident.
- Do not fire the flash near a person's eyes. It may impair the person's vision. When using flash to photograph an infant, keep at least 1 meter away.
- Before storing the camera or accessory when not in use, remove the battery pack and disconnect the power plug. This is to prevent electrical shock, heat generation, and fire.
- Do not use the equipment where there is flammable gas. This is to prevent an explosion or fire.

-
- If you drop the equipment and the casing breaks open to expose the internal parts, do not touch the internal parts due to the possibility of electrical shock.
 - Do not disassemble or modify the equipment. High-voltage internal parts can cause electrical shock.
 - Do not look at the sun or an extremely bright light source through the camera or lens. Doing so may damage your vision.
 - Keep the camera from the reach of small children. The neck strap can accidentally choke the child.
 - Do not store the equipment in dusty or humid places. This is to prevent fire and electrical shock.
 - Before using the camera inside an airplane or hospital, check if it is allowed. Electromagnetic waves emitted by the camera may interfere with the plane's instruments or the hospital's medical equipment.
 - To prevent fire and electrical shock, follow the safeguards below:
 - Always insert the power plug all the way in.
 - Do not handle a power plug with wet hands.
 - When unplugging a power plug, grasp and pull the plug instead of the cord.
 - Do not scratch, cut, or excessively bend the cord or put a heavy object on the cord. Also do not twist or tie the cords.
 - Do not connect too many power plugs to the same power outlet.
 - Do not use a cord whose insulation has been damaged.
 - Occasionally unplug the power plug and use a dry cloth to clean off the dust around the power outlet. If the surrounding is dusty, humid, or oily, the dust on the power outlet may become moist and short-circuit the outlet to cause a fire.
-

Preventing Injury or Equipment Damage

- Do not leave equipment inside a car under the hot sun or near a heat source. The equipment may become hot and cause skin burns.
 - Do not carry the camera around while it is attached to a tripod. Doing so may cause injury. Also make sure the tripod is sturdy enough to support the camera and lens.
 - Do not leave a lens or lens-attached camera under the sun without the lens cap attached. Otherwise, the lens may concentrate the sun's rays and cause a fire.
 - Do not cover or wrap the battery-recharging apparatus with a cloth. Doing so may trap heat within and cause the casing to deform or catch fire.
 - If you drop the camera in water or if water or metal fragments enter inside the camera, promptly remove the battery pack and back-up battery. This is to prevent fire and electrical shock.
 - Do not use or leave the battery pack or back-up battery in a hot environment. Doing so may cause battery leakage or a shorter battery life. The battery pack or back-up battery can also become hot and cause skin burns.
 - Do not use paint thinner, benzene, or other organic solvents to clean the equipment. Doing so may cause fire or a health hazard.
-

If the product does not work properly or requires repair, contact your dealer or your nearest Canon Service Center.

Digital Camera Model DS126281 Systems

This device complies with Part 15 of the FCC Rules. Operation is subject to the following two conditions: (1) This device may not cause harmful interference, and (2) this device must accept any interference received, including interference that may cause undesired operation.

Note: This equipment has been tested and found to comply with the limits for class B digital devices, pursuant to Part 15 of the FCC Rules. These limits are designed to provide reasonable protection against harmful interference in a residential installation. This equipment generates, uses and can radiate radio frequency energy and, if not installed and used in accordance with the instructions, may cause harmful interference to radio communications. However, there is no guarantee that interference will not occur in a particular installation. If this equipment does cause harmful interference to radio or television reception, which can be determined by turning the equipment off and on, the user is encouraged to try to correct the interference by one or more of the following measures:

- Reorient or relocate the receiving antenna.
- Increase the separation between the equipment and receiver.
- Connect the equipment into an outlet on a circuit different from that to which the receiver is connected.
- Consult the dealer or an experienced radio/TV technician for help.

The cable with the ferrite core provided with the digital camera must be used with this equipment in order to comply with Class B limits in Subpart B of Part 15 of the FCC rules.

Do not make any changes or modifications to the equipment unless otherwise specified in the manual. If such changes or modifications should be made, you could be required to stop operation of the equipment.

Canon U.S.A. Inc.
One Canon Plaza, Lake Success, NY 11042, U.S.A.
Tel No. (516)328-5600

This Class B digital apparatus complies with Canadian ICES-003.



When connecting to and using a household power outlet, use only AC Adapter Kit ACK-E6 (rated input: 100-240 V AC 50/60 Hz, rated output: 8.0 V DC). Using anything else can cause fire, overheating, or electrical shock.

IMPORTANT SAFETY INSTRUCTIONS

1. **SAVE THESE INSTRUCTIONS** — This manual contains important safety and operating instructions for Battery Charger LC-E6 & LC-E6E.
2. Before using the charger, read all instructions and cautionary remarks on (1) the charger, (2) the battery pack, and (3) the product using the battery pack.
3. **CAUTION** — To reduce risk of injury, charge only the Battery Pack LP-E6. Other types of batteries may burst, causing personal injury and other damage.
4. Do not expose the charger to rain or snow.
5. Use of an attachment not recommended or sold by Canon may result in fire, electric shock, or personal injury.
6. To reduce risk of damage to electric plug and cord, pull by plug rather than by cord when disconnecting charger.
7. Make sure cord is located so that it will not be stepped on, tripped over, or otherwise subjected to damage or stress.
8. Do not operate the charger with damaged cord or plug - replace them immediately.
9. Do not operate the charger if it has received a sharp blow, been dropped, or otherwise damaged in any way; take it to a qualified serviceman.
10. Do not disassemble the charger; take it to a qualified serviceman when service or repair is required. Incorrect reassembly may result in a risk of electric shock or fire.
11. To reduce risk of electric shock, unplug charger from outlet before attempting any maintenance or cleaning.

MAINTENANCE INSTRUCTION

Unless otherwise stated in this manual, there are no user serviceable parts inside. Refer servicing to qualified serviceman.



USA and Canada only:

The Lithium ion/polymer battery that powers the product is recyclable. Please call 1-800-8-BATTERY for information on how to recycle this battery.

For CA, USA only

Included lithium battery contains Perchlorate Material – special handling may apply. See www.dtsc.ca.gov/hazardouswaste/perchlorate/ for details.

CAUTION

RISK OF EXPLOSION IF BATTERY IS REPLACED BY AN INCORRECT TYPE.
DISPOSE OF USED BATTERIES ACCORDING TO LOCAL REGULATION.

List of the lenses with which peripheral AF points will become vertical-line or horizontal-line sensitive AF points

With the lenses listed below, the six AF points on the right and left will be horizontal-line sensitive and the upper and lower two AF points will be vertical-line sensitive. Cross-type AF is possible only with the center AF point.

EF35-80mm f/4-5.6

EF35-80mm f/4-5.6 II

EF35-80mm f/4-5.6 III

EF35-80mm f/4-5.6 USM

EF35-105mm f/4.5-5.6

EF35-105mm f/4.5-5.6 USM

EF80-200mm f/4.5-5.6 II

EF80-200mm f/4.5-5.6 USM

Software Start Guide and Instruction Manual Index

EOS DIGITAL Solution Disk	314
Installing the Software	315
Software Instruction Manual	316
Index	317



**EOS DIGITAL
Solution Disk**
(Software)



**Software
Instruction
Manual**

Software Start Guide



EOS DIGITAL Solution Disk

This disk contains various software for EOS DIGITAL cameras.

EOS Utility

With the camera connected to a personal computer, EOS Utility enables you to transfer still images and movies shot with the camera to the computer. You can also use the personal computer to set various camera settings and shoot remotely with the computer connected to the camera.

Digital Photo Professional

This software is recommended for users who mainly shoot RAW images. You can view, edit, process, and print RAW images at high speed. You can also edit JPEG images while retaining the original images.

ZoomBrowser EX (Win) / ImageBrowser (Mac)

This software is recommended for users who mainly shoot JPEG images. You can easily view, edit, organize, and print JPEG images. You can also play and edit MOV movies and extract still images from movies.

Picture Style Editor

This software is aimed at advanced users who are experienced in editing images. You can edit Picture Styles and create and save original Picture Style files.

Installing the Software

- Do not connect the camera to your computer before you install the software. The software will not be installed correctly.
- Even if a previous version of the software is installed, install the software by following the steps below (the newer version will overwrite the previous version).

1 Insert EOS DIGITAL Solution Disk (CD).

- For Macintosh, double-click to open the CD-ROM icon displayed on the desktop, and double-click on [Canon EOS Digital Installer].

2 Click [Easy Installation] and follow the on-screen instructions to install.

- For Macintosh, click [Install].



3 Click [Restart] and remove the CD once the computer restarts.

- When the computer has restarted, the installation is complete.



Software Instruction Manual

Contains the Instruction Manual files for the software programs provided.

Copying and Viewing the Instruction Manual PDFs

- 1** Insert the [Software INSTRUCTION MANUAL] CD into your computer.
- 2** Double-click the CD-ROM icon.
 - For Windows, the icon displayed in [My Computer].
 - For Macintosh, the icon is displayed on the desktop.
- 3** Copy the [English] folder to your computer.
 - Instruction Manual PDFs with the names below are copied.

	Windows	Macintosh
EOS Utility	EUx.xW_E_xx	EUx.xM_E_xx
Digital Photo Professional	DPPx.xW_E_xx	DPPx.xM_E_xx
ZoomBrowser EX / ImageBrowser	ZBx.xW_E_xx	IBx.xM_E_xx
Picture Style Editor	PSEx.xW_E_xx	PSEx.xM_E_xx

- 4** Double-click the copied PDF file.
 - Adobe Reader (Version 6.0 or later) must be installed in your computer.
 - Adobe Reader can be downloaded free from the Internet.

Index

10-sec. or 2-sec. delay.....	82
1280x720	180
1920x1080	180
1st-curtain sync.....	137
2nd-curtain sync.....	137
4- or 9-image index display.....	194
640x480	180
9-point AF auto selection	78

A

A/V OUT.....	202, 212
AC Adapter Kit	272
Access lamp.....	33
Adobe RGB.....	110
AE lock.....	122
AEB.....	121, 252
AF	76, 78
AF point.....	78
AF-ON (AF start) button.....	40
AI FOCUS (AI Focus AF).....	77
AI SERVO (AI Servo AF)	77
AI Servo AF.....	56, 77
Aperture-priority AE	116
Aspect ratio	157
Audio/video OUT.....	202, 209
Auto Lighting Optimizer.....	53, 101
Auto playback	207
Auto power off.....	28, 50
Auto reset.....	107
Auto rotate of vertical images	218
Autofocus	76, 78
Automatic selection (AF).....	78
Automatic selection of AF point	78
Av (Aperture-priority AE).....	116

B

B (Bulb).....	123
B/W	91, 93
Basic+	68, 71

Battery	24, 26, 29
Battery check.....	29
Battery Grip	29, 292
Beeper	278
Black-and-white image	68, 91, 93
Bracketing	100, 121
Bulb	123

C

C	262
 (Creative Auto).....	59
Cable	3, 202, 209, 292
Camera	
Camera shake.....	125
Clear camera settings	51
Holding the camera.....	39
Settings display	266
Camera shake	38, 39
Camera user settings	20, 262
Card.....	13, 32, 48
Card reminder	32
Format.....	48
Problem.....	33, 49
Center-weighted average metering	119
Charger	22, 24
Cleaning	229
Clear camera settings	51
Clock	30
Close-up	64
Color space	110
Color temperature	96, 98
Color tone.....	92
Continuous	106
Continuous shooting.....	81
Contrast.....	92
Copyright information	108
Cord.....	3, 202, 209, 292
Creative Auto.....	59

- Creative filters 220
 ☆ icon 4
 Crop 640x480 180
 Cross-type focusing 79
 Custom Controls 45, 257
 Custom Functions 250
- D**
- Date/Time 30
 DC coupler 272
 Depth-of-field preview ... 117, 155, 156
 Dial
 Main Dial 41
 Quick Control Dial 42
 Digital terminal 236
 Dioptic adjustment 39
 Direct printing 235
 Direct selection (AF point) 255
 DPOF 245
 Drive mode 81
 Dust Delete Data 231
- E**
- Electronic level 127
 Erase (image) 215
 Error codes 291
 Evaluative metering 119
 Exposure compensation 120
 Exposure level increments 252
 Exposure simulation 158
 Extension 107
 External Speedlite 148
 Eyecup 124
 Eye-Fi card 273
 Eyepiece cover 23, 124
- F**
- Faithful 91
 FE lock 134
 FEB 136
 File name 106
 File numbering 106
 File size 85, 181, 191
 Filter effect 93, 220
 Final image simulation 155, 177
 Fine (Image-recording quality) 84
 Firmware Ver. 280
- Flash
 Custom Functions 138
 Effective range 131
 External Speedlite 148
 FE lock 134
 Flash control 135
 Flash exposure
 compensation 132
 Flash off 58
 Flash-sync speed 130, 149, 253
 Manual flash 136, 147
 Red-eye reduction 131
 Shutter sync.
 (1st/2nd curtain) 137
 Wireless 139
 Flash exposure compensation 132
 Flash mode 136
 Flash-sync contacts 16
 Focus confirmation light 54
 Focus lock 56
 Focus mode switch 34, 80, 167
- Focusing
 AF mode 76
 AF point selection 78, 255
 AF-assist beam 79
 Beeper 278
 Difficult-to-focus subjects ... 80, 164
 Manual focusing 80, 167
 Out of focus 38, 39, 80, 164
 Recompose 56
- Folder Create/Select 104
 Format 48
 Format (card initialization) 48
 Frame rate 180

Full Auto.....	54
Full HD.....	171
Full High-Definition.....	180, 202, 209
Function availability table.....	276

G

Grainy B/W.....	221
Grid display.....	157, 185

H

HDMI.....	202, 209
HDMI CEC.....	211
High ISO speed noise reduction ...	254
High-Definition.....	180, 202, 209
Highlight alert.....	192
Highlight detail loss.....	192
Highlight tone priority.....	183, 255
Histogram (Brightness/RGB).....	193
Hot shoe.....	149
Household power outlet.....	272

I

ICC profile.....	110
Illumination (LCD panel).....	43
Image	
AF point display.....	193
Auto playback.....	207
Auto rotate.....	218
Erased.....	215
Highlight alert.....	192
Histogram.....	193
Index.....	194
Jump display	
(Image browsing).....	195
Magnified view.....	196
Manual rotate.....	197
Playback.....	189
Processing.....	219
Protect.....	213
Quick Control.....	44, 67, 200
Shooting information.....	191
View on TV.....	202, 209

Image area.....	36
Image dust prevention.....	229
Image review time.....	50
Image Stabilizer (lens).....	38
Image transfer.....	273
Image verification data.....	260
Image-recording quality.....	84
Index display.....	194
ISO speed.....	88, 175, 251, 267
Auto.....	89
ISO expansion.....	252
Setting increments.....	252

J

JPEG.....	84
Jump display.....	195

L

Landscape.....	63, 90
Language selection.....	31
Large (Image-recording quality).....	85
LCD monitor.....	13, 27
Brightness adjustment.....	217
Image playback.....	189
Menu screen.....	46, 278
Shooting settings display.....	267
Vari-Angle.....	27, 57
LCD panel.....	18
Lens.....	21, 34
Lock release.....	35
Peripheral illumination	
correction.....	102

Live View shooting	57, 151
Exposure simulation	158
Face detection	
Live mode (AF)	161
Grid display	157
Information display	154
Live mode (AF)	160
Manual focusing	80, 167
Metering timer	159
Possible shots	153
Quick Control	156
Quick mode (AF)	165
Silent shooting	159
Long exposure noise reduction	254
Long exposures	123

M

M (Manual exposure)	118
Magnified view	167, 196, 225
Main Dial	41
Malfunction	283
Manual exposure	118, 174
Manual focusing	80, 167
Manual reset	107
Manual selection (AF)	78
Maximum burst	85, 87
Medium (Image-recording quality)	85, 222
Memory card	32, 48
Menu	46
Menu settings	278
My Menu	261
Setting procedure	47

MENU icon	4
Metering mode	119
MF (Manual focusing)	80, 167
Miniature effect	221
Mirror lockup	125, 257
Mode Dial	20, 41
Monochrome image	68, 93

Movie	171
AF mode	179, 182
Editing	206
Editing first/last scene	206
Enjoying	202
File size	181
Frame rate	180
Grid display	185
Information display	176
Manual exposure	174
Metering timer	185
Movie recording size	180
Playback	204
Quick Control	179
Recording time	181
Silent shooting	185
Sound recording	184
Still photo shooting	178
View on TV	202, 209
Multi-controller	43, 78
My Menu	261

N











Neutral	91
Night Portrait	66
Noise reduction	
High ISO speed	254
Long exposures	254
Nomenclature	16
Non-Canon flash units	149
Normal (Image-recording quality)	84
NTSC	180, 212, 280
No	106

O

ONE SHOT (One-Shot AF)	76
One-Shot AF	76

P

P (Program AE)	112
PAL	180, 212, 280
Partial metering	119

- Peripheral illumination correction..102
 Personal white balance.....98
 PictBridge.....235
 Picture Style.....90 - 95
 Pixels.....84
 Playback.....189
 Portrait.....62, 90
 Possible shots.....29, 85, 153
 Power
 Auto power off.....50
 Battery check.....29
 Battery info.....268
 Household power.....272
 Possible shots.....29, 85, 153
 Recharge.....24
 Pressing completely.....40
 Pressing halfway.....40
 Print.....235
 Printing.....235
 Layout.....239
 Paper settings.....239
 Print Order (DPOF).....245
 Printing effects.....240
 Tilt correction.....243
 Trimming.....243
 Program AE.....112
 Program shift.....113
 Protect (image erase-protection) ..213
- Q**
-  (Quick Control).....44, 67, 200
 Quick Control.....44, 67, 200
 Quick Control Dial.....42
 Quick mode (AF).....165
- R**
- Rating.....198
 Rating mark.....198
 RAW.....84, 86
 RAW image processing.....224
 RAW image processing
 with the camera.....224
 RAW+JPEG.....84
 Recharge.....24
 Recharge performance (Battery)..268
 Red-eye reduction.....131
 Release shutter without card.....32
 Remote control shooting.....124, 126
 Remote switch.....124
 Resize.....222
 Rotate (image).....197, 218, 243
- S**
- Safety shift.....253
 Safety warnings.....305
 Saturation.....92
 SD card.....32, 48
 SDHC and SDXC cards.....32
 Self-timer.....67, 82
 Sensor cleaning.....229
 Sepia (Monochrome).....68, 93
 Sharpness.....92
 Shoot by ambience selection.....68
 Shoot by lighting or scene type.....71
 Shooting information display.....191
 Shooting mode.....20
 Av (Aperture-priority AE).....116
 B (Bulb).....123
 M (Manual exposure).....118
 P (Program AE).....112
 Tv (Shutter-priority AE).....114
  (Full Auto).....54
  (Flash Off).....58
  (Creative Auto).....59
  (Portrait).....62
  (Landscape).....63
  (Close-up).....64
  (Sports).....65
  (Night Portrait).....66
  (Movie shooting).....171

Shooting settings display 43, 267
 Shutter button 40
 Shutter sync 137
 Shutter-priority AE 114
 Silent shooting 159, 185
 Single image display 190
 Single shooting 61, 81
 Single-point AF 78
 Slide show 207
 Small
 (Image-recording quality) 85, 222
 Soft focus 221
 Sports 65
 Spot metering 119
 sRGB 110
 Stopped-down
 aperture 117, 155, 156
 Strap 23
 System map 292

T

Tone priority 183, 255
 Toning effect (Monochrome) 93
 Toy camera effect 221
 Trimming (printing) 243
 Tripod socket 17
 Tv (Shutter-priority AE) 114

U

UNLOCK button 42
 USB (Digital) terminal 236
 User settings 262

V

Vari-Angle LCD monitor 27, 57
 Video system 180, 212, 280
 View on TV 202, 209
 Viewfinder 19
 Dioptic adjustment 39
 Electronic level 127

Volume (Movie playback) 205

W

WB 96
 White balance 96
 Bracketing 100
 Correction 99
 Custom 97
 Personal 98
 Wind filter 185
 Wireless remote control 126

Canon

CANON INC. 30-2, Shimomaruko 3-chome, Ohta-ku, Tokyo 146-8501, Japan

U.S.A. ————— **CANON U.S.A. INC.**

One Canon Plaza, Lake Success, NY 11042-1198, U.S.A.
For all inquiries concerning this product, call toll free in the U.S.
1-800-OK-CANON

CANADA ————— **CANON CANADA INC. HEADQUARTERS**

6390 Dixie Road, Mississauga, Ontario L5T 1P7, Canada

CANON CANADA INC. MONTREAL BRANCH

5990, Côte-de-Liesse, Montréal Québec H4T 1V7, Canada

CANON CANADA INC. CALGARY OFFICE

2828, 16th Street, N.E. Calgary, Alberta T2E 7K7, Canada

For all inquiries concerning this product, call toll free in Canada
1-800-OK-CANON

EUROPE, ————— **CANON EUROPA N.V.**

AFRICA &

Bovenkerkerweg 59-61, 1185 XB Amstelveen, The Netherlands

MIDDLE EAST

CANON FRANCE S.A.S.

17, Quai du Président Paul Doumer, 92414 Courbevoie Cedex, France

CANON UK LTD.

Woodhatch Reigate, Surrey RH2 8BF, United Kingdom

CANON DEUTSCHLAND GmbH

Europark Fichtenhain A10, 47807 Krefeld, Germany

CANON ITALIA S.p.A.

Via Milano 8, 20097 San Donato Milanese, (MI), Italy

CANON Schweiz A.G.

Industriestrasse 12, 8305 Dietlikon, Switzerland

Canon GmbH

Zetschegasse 11, A-1230 Vienna, Austria

CANON España, S.A.

Av. De Europa, 6 Alcobendas 28108 Madrid, Spain

CANON Portugal S.A.

Rua Alfredo da Silva, 14 Alfragide 2610-016 Amadora, Portugal

CENTRAL & ————— **CANON LATIN AMERICA, INC.**

SOUTH AMERICA

703 Waterford Way, Suite 400 Miami, FL 33126, U.S.A.

ASIA ————— **CANON (China) Co., LTD.**

15F Jinbao Building No.89 Jinbao Street, Dongcheng District, Beijing 100005, China

CANON HONGKONG CO., LTD.

19/F., The Metropolis Tower, 10 Metropolis Drive, Hunghom, Kowloon, Hong Kong

CANON SINGAPORE PTE. LTD.

1 HarbourFront Avenue, #04-01 Keppel Bay Tower, Singapore 098632

CANON KOREA CONSUMER IMAGING INC.

Canon BS Tower 5F, #168-12 Samseong-dong, Gangnam-gu, Seoul, Korea

OCEANIA ————— **CANON AUSTRALIA PTY. LTD.**

1 Thomas Holt Drive, North Ryde, Sydney N.S.W. 2113, Australia

CANON NEW ZEALAND LTD.

Akoranga Business Park, Akoranga Drive, Northcote, Auckland, New Zealand

JAPAN ————— **CANON MARKETING JAPAN INC.**

16-6, Kohnan 2-chome, Minato-ku, Tokyo 108-8011, Japan

This Instruction Manual booklet is current as of August 2010. For information on the camera's compatibility with any accessories and lenses introduced after this date, contact any Canon Service Center.